



National Aeronautics and  
Space Administration

Educational Product

Teachers  
and Students

Grades 5-9

EG-2003-03-010 GRC

# Amusement Park Physics With a NASA Twist



**A Middle School Guide  
for Amusement Park Physics Day**

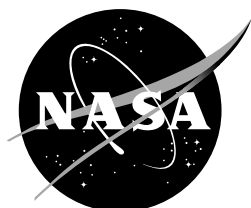

*Amusement Park Physics With a NASA Twist* is available in electronic format through NASA Spacelink—one of the Agency's electronic resources developed for use by the educational community. This publication and other educational products may be accessed at the following address:

<http://spacelink.nasa.gov/products>

*About the cover: This picture of the Corkscrew was taken at Cedar Point in Sandusky, Ohio.  
Used with permission. ©1995 Joe Schwartz www.joyrides.com*



# Amusement Park Physics With a NASA Twist

**A Middle School Guide  
for Amusement Park Physics Day**

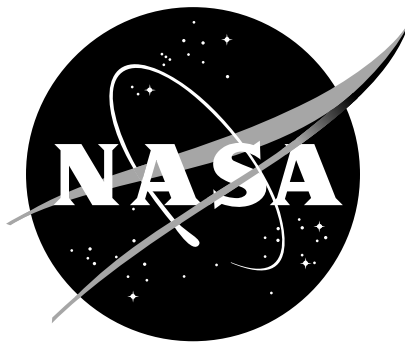

**National Aeronautics and Space Administration**

**NASA Glenn Research Center**  
Microgravity Science Division  
National Center for Microgravity Research on Fluids and Combustion  
Office of Educational Programs

**NASA Headquarters**  
Office of Biological and Physical Research

This publication is in the public domain and is not protected by copyright.  
Permission is not required for duplication for classroom use.  
For all other uses, please give credit to NASA and the authors.

EG-2003-03-010-GRC



## Acknowledgments

The K–12 Educational Program group at the National Center for Microgravity Research on Fluids and Combustion developed this educator guide at the NASA Glenn Research Center in Cleveland, Ohio. This publication is a product of 4 years of development and testing with over 1500 students at Six Flags and Cedar Point in Ohio. Special thanks go to the teachers who formally piloted this program with over 900 students. Their feedback was invaluable.

### *Project manager:*

Carla B. Rosenberg  
National Center for Microgravity  
Research on Fluids and Combustion  
Cleveland, Ohio

### *Pilot teachers:*

William Altman  
Horace Mann Middle School  
Lakewood, Ohio

Michael Eier  
Glenwood Middle School  
Findlay, Ohio

### *Contributing authors:*

Carol Hodanbosi, Ph.D.  
Carla B. Rosenberg  
National Center for Microgravity  
Research on Fluids and Combustion  
Cleveland, Ohio

Megan Bolvin  
Roosevelt Middle School  
Springfield, Ohio

Cindy Mast  
Emerson Middle School  
Lakewood, Ohio

Wendy Booth  
Fairport Harbor High School  
Fairport Harbor, Ohio

James Nold  
Hudson Middle School  
Hudson, Ohio

Samantha Beres  
Chimayo, New Mexico

Matthew Broda  
Erwine Middle School  
Akron, Ohio

Elaine Peduzzi  
Ford Middle School  
Brook Park, Ohio

Melissa J. B. Rogers  
Macedonia, Ohio

Rick Chiera  
Bolich Middle School  
Cuyahoga Falls, Ohio

Karen Rayl  
Wickliffe Middle School  
Wickliffe, Ohio

Ann Schwartz  
Emerson Middle School  
Lakewood, Ohio

Debbie Dobney  
McCormick Middle School  
Wellington, Ohio

Michelle Smith  
Hillside Middle School  
Seven Hills, Ohio

### *Reviewers/editors*

Richard DeLombard  
NASA Glenn Research Center  
Cleveland, Ohio

Thomas Jacobson  
National Center for Microgravity  
Research on Fluids and Combustion  
Cleveland, Ohio

John Fellenstein  
Max Hayes Vocational High School  
Cleveland, Ohio

*Special thanks to photographer Joe Schwartz for his permission to use his ©1995 pictures on the following pages:  
7, 9, 15 (2), 37, 38, 64, 65, 67, 68 (2), 69, 71 (3), 73, 78, 80 (2), 82, 83 (2), 85, 86, 95, 112, 121.*



# Table of Contents

Introduction .....	7
Correlation to National Education Standards.....	11
Background .....	14
Basic Skills .....	26
Time .....	26
Distance .....	26
Eye Level Height .....	27
Altitude Tracker .....	28
Altitude Tracker Template .....	29
Altitude Estimation Methods.....	31
Scale Drawing Method .....	31
Altitude Tracker Worksheet .....	32
Flagpole Height Worksheet .....	34
Structure Estimation .....	35
Structure Estimation Worksheet.....	37
Accelerometer .....	39
Errors in Measurement.....	41
Classroom Activities .....	43
Pendulums—Part 1 .....	45
Pendulums—Part 2 .....	47
Collisions—Part 1 .....	49
Collisions—Part 2 .....	50
Marble Run—Part 1 .....	52
Marble Run—Part 2.....	53
Marble Run—Part 3.....	55
Marble Run—Part 4.....	57
NASA Connection .....	59
Student Reading Guide .....	61
Student Reading Guide Answer Key .....	62
Free-Fall Rides .....	64
Roller Coasters .....	65
Bumper Cars .....	66
Carousels .....	67
Roller Coasters—Loops .....	68
Pendulum Rides .....	69
Ride Work Book .....	71
Free-Fall Rides .....	73
Roller Coasters—Initial Hill .....	75
Bumper Cars .....	77
Roller Coasters—Floater Hills .....	79
Carousels .....	81
Roller Coasters—Loops .....	82
Pendulum Rides .....	84
Worksheets for Nonattending Students.....	86



Answer Key .....	98
Pendulums—Part 1 .....	98
Pendulums—Part 2 .....	100
Collisions—Part 1 .....	102
Collisions—Part 2 .....	103
Marble Run—Part 1 .....	105
Marble Run—Part 2 .....	106
Marble Run—Part 3 .....	108
Marble Run—Part 4 .....	110
Free-Fall Rides .....	112
Roller Coasters—Initial Hill .....	114
Bumper Cars .....	116
Roller Coasters—Floater Hills .....	118
Carousels .....	120
Roller Coaster—Loops .....	121
Pendulum Rides .....	122
Tests .....	125
Pretest .....	127
Pretest Answer Key .....	128
Post Test .....	129
Post Test Answer Key .....	130
Forms and Extras .....	131
Announcement and Contract .....	133
Permission, Emergency Information, and Refusal of Consent .....	134
Ride Station Rotation Chart .....	135
Eye Level Height and Stepping Estimation Record .....	136
Classroom Master Materials List .....	137
Amusement Park Day Master Materials List .....	138
Bus List .....	139
Ride Attendance Form .....	140
Resources .....	141
Vocabulary .....	143
List of Formulas .....	144
Amusement Park Physics and Related Web Sites .....	145
NASA Resources for Educators .....	146



## INTRODUCTION

Amusement parks have a long tradition of hosting physics days. Students look forward to the field trip—after all, they get to go to an amusement park for the day—and it's educational. Teachers like the excitement that the event generates, while providing them with a situation in which to apply concepts of measurement, estimation, gravity, motions, forces, and systems. Students are engaged in the inquiry process to gather data firsthand and apply what they've learned to a real situation. The results may be more or less accurate, but the process is an authentic opportunity to conduct real science and apply math concepts in contexts outside of the classroom (Standard 9c, National Mathematics Content Standards by the National Council of Teachers of Mathematics (NCTM)). This type of an educationally rich experience, which meets state and national standards, increases the likelihood of school administrations approving the field trip. Organizing a field trip is an undertaking. The goal of this guide is to make the teachers' jobs simpler to facilitate and adequately prepare students for a successful learning experience at the amusement park.

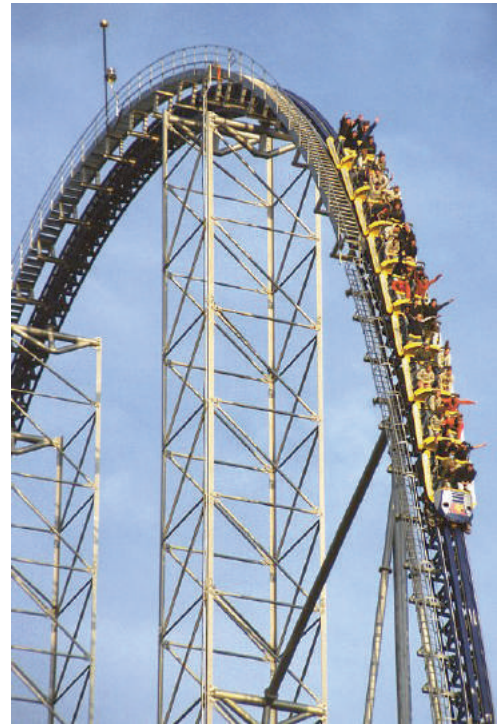

*Cedar Point's Magnum XL-200 has a lift hill that is over 200 feet tall. The coaster has no loops in its out-and-back course. The Magnum XL-200 is located at Cedar Point, Sandusky, Ohio.*

### **What does amusement park physics have to do with NASA?**

While many guides relating to amusement park physics exist, this guide is unique because it examines how the physics of motion applies to aeronautics and astronautics. Amusement parks are one of the best places to feel firsthand what astronauts experience while in space. For example, during launch, the thrust of the space shuttle's engines cause astronauts to experience forces up to three times Earth's gravity (3 g). Some roller coasters give riders up to 3.7 g. Likewise, weightless conditions experienced during astronaut training and on orbit can be felt on amusement park rides that plummet straight down or crest over hills. This guide contains a section that makes the NASA connection for specific amusement park rides.

### **How did this guide develop?**

NASA Glenn Research Center in Cleveland, Ohio, has long supported Amusement Park Physics Days at Cedar Point, Geauga Lake, and now Six Flags. Scientists and engineers volunteer each year to visit schools and go to the parks to demonstrate and explain how NASA ties into amusement park physics, particularly with the two drop towers at Glenn Research Center. Teachers attending NASA educator workshops and the amusement parks expressed interest in developing a guide in partnership with the National Center for Microgravity Research (NCFMR). In particular, educators from Emerson Middle School in Lakewood, Ohio, have partnered closely with NCFMR. This guide has been developed over the past 4 years, creating activities, testing them at the park with over 1500 students, and revising the materials according to successes and failures. As a result, the draft of the guide reached a sufficient degree of quality for a formal pilot program with educators throughout Ohio. Now with completion of the pilot program the guide has been revised and is available nationally online through NASA Spacelink ([spacelink.nasa.gov](http://spacelink.nasa.gov)) and through the NASA Educator Resource Network (see page 146).



## For what grades is this guide appropriate?

Many amusement park physics guides are geared toward high school level science and mathematics classes. This guide does not require knowledge of trigonometry or calculus. The intended audience is primarily students in seventh through ninth grades. Since high school level mathematics are not used and the measurement tools are fairly low-end technologies, and not terribly accurate, the emphasis is less on getting the “correct” answer and more about making reasonable estimations and the thinking process. Note, upper elementary school teachers have found this guide to be appropriate for classes for gifted and talented students. However, this age group may lack the necessary motor skills to operate stop watches and take consistent altitude tracker readings.

## How is this amusement park guide different from other guides?

Most amusement park physics guides focus primarily on problem sets and are geared towards using trigonometry and calculus. This is a middle school guide that makes the NASA connection to the rides. All of the activities are centered on preparing students to complete worksheets for specific rides. The science and mathematics teachers can prepare students to use a single method or several methods for gathering the data. In addition, the guide is geared to help plan and run a successful field trip. After having many amusement park field trips, in all types of weather, with all types of students, and involving teachers of many different subjects, we have learned a lot about what works and what does not. Included in this guide you will find what the teachers found to be most essential in preparing and running this field trip.

## How to use this guide

The sections found in the guide include

- **Background Information**—covers amusement park physics, gravity, forces and motion, and microgravity. This information is for the teacher, but may also be given out to the students.
- **Basic Skills**—discusses skills needed to do classroom activities and ride work sheets at the amusement park. Skills involve using a stopwatch, walking baselines, taking altimeter readings, calculating heights and speeds, and making and using accelerometers.
- **Classroom Activities**—contains 2 weeks worth of activities designed to provide students with skills needed to complete ride worksheets at the park.
- **NASA Connections**—makes the NASA tie-in with each amusement park ride.
- **Ride Worksheets**—can be used as a workbook for specific rides at the amusement park.
- **Answer Key**—gives approximate answers for each of the classroom activities and ride worksheets.
- **Tests**—provides a pretest and post test to show students and teachers how much they have learned from this unit on motion and forces.
- **Forms and Extras**—includes tips and forms to help get the trip organized and methods for facilitating a successful experience at the park.
- **Resources**—covers vocabulary, formula list, Web sites, and other useful NASA resources for educators.





To get a sense of the scope of the content, read through the Ride Worksheets and Answer Key sections first. Remember that for middle school students, the emphasis is less on getting a “correct” answer than using the problem-solving process. The measurement tools are not highly accurate, but if used correctly can provide comparative values. The basic skills and classroom activities prepare students to successfully complete the ride worksheets at the park. If you or your students need more science and math information related to forces and motion, consult the background information. The Background Information section can be used as a student handout or as a teacher reference.

Plan on spending at least 2 weeks prior to the spring field trip working on the classroom activities. Ideally, the science and mathematics teachers should work closely together to coordinate teaching basic skills. One option is to begin the unit with the pretest to see what students know about motion and forces. Then give the post test after the field trip to see what the students have learned. The English teacher can assist in the preparation process too by reinforcing or even introducing the NASA Connections section with a worksheet activity.

When it comes to organizing the field trip, read through the planning schedule that follows. We recommend generating interest and support from school administrators, parents, students, and fellow teachers early in the semester in which you plan to implement this guide. Some schools have had success with high school physics students assisting student teams at the amusement park. Many schools have fundraisers to subsidize paying for school buses, purchasing measurement equipment, and even partially or completely paying for the students’ tickets. The forms and extras section includes a letter of permission for parents, ways to keep track of supply bags, teams of students, and attendance lists for riding the buses. From past experience, teachers and parents that volunteer to be of assistance at the amusement park prefer to just learn the worksheet for their particular assigned ride station. If possible, attend an amusement park physics workshop for educators at NASA Glenn Research Center. Visit [www.ncmr.org/education/k12/workshops.html](http://www.ncmr.org/education/k12/workshops.html) for information on future workshops.



*The Dungeon Drop, located at Six Flags AstroWorld in Houston, Texas, stands 230 feet high. The feeling of weightlessness the riders experience is enhanced by extending their arms and legs.*



## Planning Schedule

### September

- Check with administrators (superintendent, building principal) for trip approval.
- Check school master schedule to avoid conflicts and set the field trip day in May.

### January

- Make bus arrangements.
- Make ticket arrangements with park, finalizing ticket prices.

### February

- Order needed supplies from science catalogs.

### March

- Send out student contracts and information sheets.
- Recruit teacher/parent volunteers (seven).

### April (mid)

- Send out permission forms to parents.
- Gather all necessary materials and supplies.
- Make student bags (altitude tracker, calculator, stopwatch, pen, and ruler).
- Begin teaching unit (2 to 3 weeks).
- Begin collecting money from students.

### April (late)

- Decide on ride order.
- Divide students into teams.
- Make the rotation order for rides.
- Train teacher volunteers about his/her ride.

### May

- Make a bus list 3 days before the field trip.
- One day before
  - Review ride worksheets with students.
  - Review rules of behavior at park; where and when to meet on arrival and departure; what to do in case of inclement weather or medical emergencies; what they need to take with them; what clothing to take in case of rain; and appropriate dress.
  - Take all of the students' medical emergency forms with you.
  - Give teacher packets to each volunteer containing a bus list, an eye height and stepping estimation record sheet, answer keys for all rides, a clipboard, a pencil, and a ride attendance sheet.
- On the morning of the trip
  - Give each student team the names of teachers that are stationed at each ride.
  - Give directions to the teachers that are assigned to a station that they should sign each student team's sheet after they have completed the questions for that ride station.
  - Leave the unattending students' ride worksheets for substitute teacher to pass out.
  - Check the materials list form to make sure you have everything. It is strongly suggested that extra ride worksheets and other student supplies are brought to the amusement park.
  - Buy doughnuts for the teachers/parent volunteers (optional).



**National Science Education Standards, Grades 5–8  
by the National Research Council, 1996**

	<b>Basic Skills</b>			
<b>Science Standard</b>	Altimeter angles	Flagpole height	Structure estimation	NASA connection
<b>Unifying Concept and Processes</b>				
Evidence, models, and organization				●
Change, constancy, and explanation	●	●	●	
<b>Science as Inquiry</b>				
Abilities necessary to do scientific inquiry	●	●	●	
Understanding scientific inquiry				●
<b>Physical Science</b>				
Motions and forces				●
Transfer of energy				●
<b>Science and Technology</b>				
Understanding science and technology			●	●
<b>Science in Personal and Social Perspectives</b>				
Risk and benefits				●
Science and technology in society				●
<b>History and Nature of Science</b>				
Nature of science				●
History of science				●

**Mathematics Principles and Standards for Schools, Grades 5–8  
by the National Council of Teachers of Mathematics, 2000**

	<b>Basic Skills</b>			
<b>Mathematics Standard</b>	Altimeter angles	Flagpole height	Structure estimation	NASA connection
<b>Number and Operations</b>				
Representing numbers		●	●	
Meanings of operations	●	●		
Compute fluently	●	●	●	
<b>Algebra</b>				
Mathematical models	●	●		
<b>Geometry</b>				
Apply transformation	●	●		
Use visualization	●	●	●	●
<b>Measurement</b>				
Measurable attributes	●	●	●	
Appropriate techniques, tools, formulas	●	●	●	
<b>Problemsolving</b>				
Build new math knowledge	●	●	●	●
Solve problems that arise	●	●	●	
Apply appropriate strategies	●	●	●	
<b>Connections</b>				
Apply math in contexts outside of math	●	●	●	●
<b>Representation</b>				
Use representations to model world phenomena		●	●	●



**National Science Education Standards, Grades 5–8  
by the National Research Council, 1996**

	<b>Classroom Activities</b>							
<b>Science Standard</b>	Collisions Part 1	Collisions Part 2	Marble Run Part 1	Marble Run Part 2	Marble Run Part 3	Marble Run Part 4	Pendulums Part 1	Pendulums Part 2
<b>Unifying Concept and Processes</b>								
Systems, order, and organization	●	●	●	●	●			
Evidence, models, and organization	●	●	●	●	●	●	●	●
Change, constancy, and explanation	●	●	●	●	●	●	●	●
Evolution and equilibrium	●	●						
<b>Science as Inquiry</b>								
Abilities necessary to do scientific inquiry	●	●	●	●	●	●	●	●
Understandings about scientific inquiry	●	●	●	●	●	●	●	●
<b>Physical Science</b>								
Motions and forces	●	●	●	●	●	●	●	●
Transfer of energy		●	●		●			

**Mathematics Principles and Standards for Schools, Grades 5–8  
by the National Council of Teachers of Mathematics, 2000**

	<b>Classroom Activities</b>							
<b>Mathematics Standard</b>	Collisions Part 1	Collisions Part 2	Marble Run Part 1	Marble Run Part 2	Marble Run Part 3	Marble Run Part 4	Pendulums Part 1	Pendulums Part 2
<b>Number and Operations</b>								
Representing numbers				●	●		●	●
Meanings of operations				●	●		●	●
Compute fluently				●	●		●	●
<b>Algebra</b>								
Patterns				●	●			
Represent and analyze				●	●			
Mathematical models	●	●		●	●		●	●
Analyze change				●	●			
<b>Geometry</b>								
Apply transformation				●	●			
Use visualization				●	●			
<b>Measurement</b>								
Measurable attributes				●	●		●	●
Appropriate techniques, tools, formulas				●	●		●	●
<b>Data Analysis and Probability</b>								
Select and use statistical methods					●	●	●	●
Develop and evaluate					●		●	●
<b>Problemsolving</b>								
Build new math knowledge				●	●		●	●
Solve problems that arise	●	●	●	●	●	●	●	●
Apply appropriate strategies	●	●	●	●	●	●	●	●
<b>Connections</b>								
Apply math in contexts outside of math				●	●		●	●
<b>Representation</b>								
Use representations to model world phenomena	●	●		●	●		●	●



**National Science Education Standards, Grades 5–8  
by the National Research Council, 1996**

	<b>Ride Worksheets</b>						
<b>Science Standard</b>	Bumper Cars: Collisions	Carousel	Free-Fall Ride	Pendulum Ride	Roller Coaster: Floater Hills	Roller Coaster: Initial Hill	Roller Coaster: Loop
<b>Unifying Concept and Processes</b>							
Systems, order, and organization	●	●	●	●	●	●	●
Evidence, models, and organization	●	●	●	●	●	●	●
Change, constancy, and explanation	●						
<b>Science as Inquiry</b>							
Abilities necessary to do scientific inquiry	●	●	●	●	●	●	●
Understanding scientific inquiry	●	●	●	●	●	●	●
<b>Physical Science</b>							
Motions and forces	●	●	●	●	●	●	●
Transfer of energy	●		●				

**Mathematics Principles and Standards for Schools, Grades 5–8  
by the National Council of Teachers of Mathematics, 2000**

	<b>Ride Worksheets</b>						
<b>Mathematics Standard</b>	Bumper Cars: Collisions	Carousel	Free-Fall Ride	Pendulum Ride	Roller Coaster: Floater Hills	Roller Coaster: Initial Hill	Roller Coaster: Loop
<b>Number and Operations</b>							
Representing numbers		●	●	●	●	●	
Meanings of operations		●	●	●	●	●	
Compute fluently		●	●	●	●	●	
<b>Algebra</b>							
Patterns		●		●	●	●	
Represent and analyze				●	●	●	
Mathematical models						●	
Analyze change						●	
<b>Geometry</b>							
Apply transformation			●	●	●	●	
Use visualization			●	●	●		
<b>Measurement</b>							
Measurable attributes		●	●	●	●	●	
Appropriate techniques, tools, formulas		●	●	●	●	●	
<b>Data Analysis and Probability</b>							
Select and use statistical methods					●	●	
<b>Problemsolving</b>							
Build new math knowledge			●	●	●	●	
Solve problems that arise	●	●	●	●	●	●	●
Apply appropriate strategies	●	●	●	●	●	●	●
<b>Connections</b>							
Apply math in contexts outside of math		●	●	●	●	●	
<b>Representation</b>							
Use representations to model world phenomena			●	●	●	●	



## BACKGROUND

Why are amusement park rides so much fun? The roller coasters, free-fall, and pendulum rides are exhilarating, if not terrifying. Think about how the motion of a ride heightens one's senses. The roller coaster creeps to the top of a hill slowly. Anticipation builds. As it crests the hill, the car seems suspended for a moment before it thunders down and the car and rider are falling fast. It feels like one might fly out of the car if not for the safety restraints. The boat ride that swings like a pendulum looks harmless, but as it swings higher and higher in its arc, the rider comes off his or her seat. One feels suspended in midair just long enough to give one's stomach a flutter.

*Microgravity does not mean a little bit of gravity. It means that some of the effects of gravity are minimized.*

Believe it or not, science explains the thrills one experiences on the roller coaster and other rides. An amusement park is a great place to study motions and forces, and something different called microgravity.

### Microgravity

**Microgravity** is not what it sounds like. Although “micro” means small, “microgravity” does not mean a little bit of **gravity**; it means that some of the effects of gravity are minimized. Amusement park rides provide brief glimpses of what astronauts experience in the microgravity of orbit—a sense of weightlessness. The gravitational pull in an amusement park does not change from place to place, but one will experience a sensation of feeling heavier, lighter, even weightless, on some rides.

### Motion Makes All the Commotion

Amusement park rides are exciting because of a common element that they all share. What do merry-go-rounds, ferris wheels, flume rides, and bumper cars have in common? All these rides have motion. What would a roller coaster be without motion? It is the motion of a ride that can move one in such a way that one feels heavy, as if gravity became stronger. The motion can also let one fall for a second or more, making one feel light or weightless. Motions can change the effect that gravity has on one's body, enough to create a microgravity environment.

Three types of motion found at amusement parks relate to the sensations one feels—linear motion, curved motion, and circular motion. Linear motion describes an object that moves in a straight line. Bumper cars move in a horizontal, linear

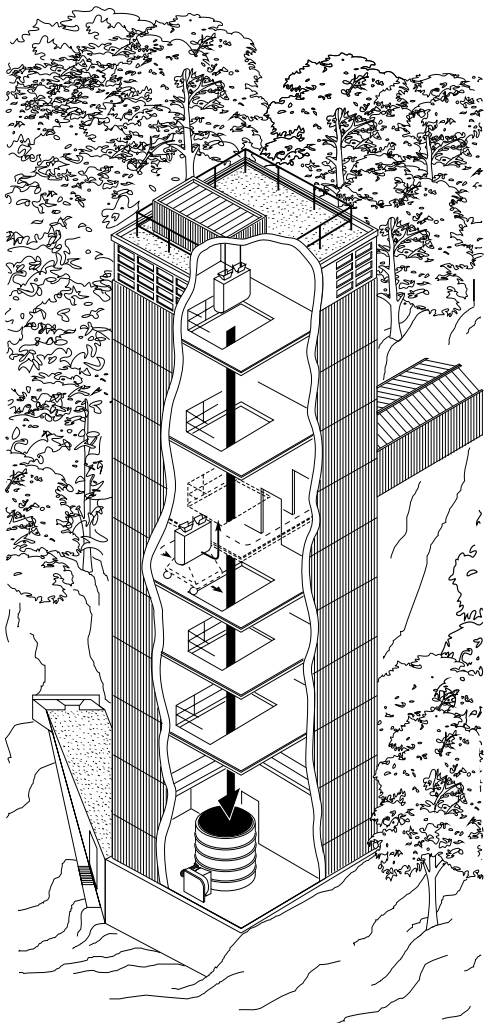

*NASA has a number of ways to create microgravity for research. This drop tower at the Glenn Research Center in Cleveland, Ohio, creates a microgravity environment.*



path much of the time. The free-fall ride makes a vertical, or up-and-down, type of linear motion. Roller coasters use a combination of horizontal and vertical linear motion, as well as curved motion, as the cars charge over hills and careen around corners. The pendulum ride, though it may not always travel in a complete circle, moves in a circular path, as does the ferris wheel. These types of motion contribute to the chills and thrills of the rides. Knowing these three types of motion will come in handy when one wants to compare a ride, like the free fall, to something outside of the amusement park, such as a drop tower. Both, obviously, have vertical and linear motion.

### The Measure of Motion

There is more to motion than just the path an object takes. One can determine if one will feel heavier, lighter, or weightless by studying its motion beforehand. By measuring the ride's position at different times, one can find its displacement, velocity, and acceleration.

The position of a ride is where it is at any given moment. Imagine a giant ruler that could be held up next to a free-fall ride to measure the car's position during the ride. One might place the zero point of the ruler at ground level and label it as  $Y_f$ , for the final height. If the ride is 30 meters tall, then the position of the car at the start is 30 meters and is labeled  $Y_i$ , for the initial height. This causes the location of the car's position at the start to be positive, since it is above the ground. After 1 second of fall, the car's position will be 25 meters. After 2 seconds, the position will be 10 meters and after less than 2.5 seconds the position will be zero with the rider located at the bottom of the ride.

### Displacement

When a ride changes position, one can calculate the difference between these two positions. This is called finding the **displacement**. When the free-fall ride is over, the displacement of the car is found by subtracting its starting or initial height from its ending or final height ( $Y_f - Y_i$ , or 0 meters - 30 meters = -30 meters).

### Frames of Reference

In the first example, the giant ruler was used to define a reference frame in which zero is at the ground level and upward is positive. However, the lowest point of a ride may be above the ground level. In a second example, one may want to move the ruler to change the reference frame, to

Three types of motion that are found in amusement parks are

1. Linear motion
2. Curved motion
3. Circular motion



*This drop tower ride is an example of a ride having linear motion.*



*The path going down a roller coaster hill is one example of curved motion.*



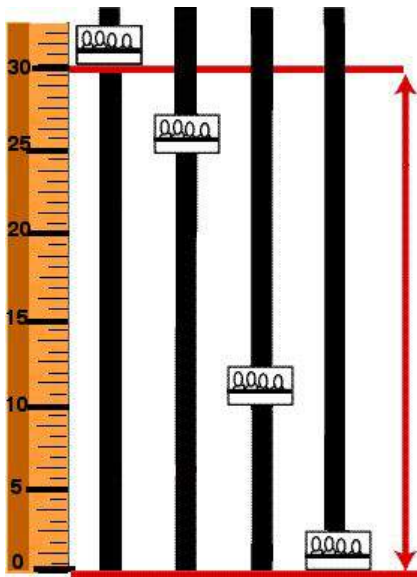

The starting height at 30 meters, which is above the ground level, and the ending height at 0 meters, which is ground level.

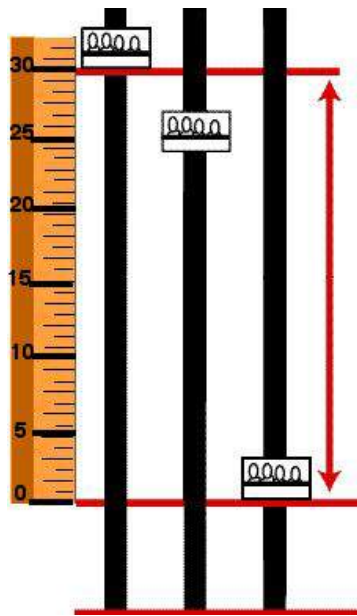

The starting height is above the ground level at 30 meters, and the ending height is also above ground level at 0 meters.

Displacement, velocity, and acceleration have both magnitude (size) and direction.

define zero to be at the lowest point of the ride (see diagram). Using this frame of reference, when the rider moved downward from the starting height, the displacement is negative. Note, nothing has changed other than the location of the ruler, which defines the frame of reference and the location of zero. The motion of the ride will still be the same. Frames of reference are often defined in such a way as to make calculations as simple as possible.

### Velocity

Determining the **velocity** of a ride will tell you how fast the ride is falling at any given moment (e.g., 5 meters per second), or how fast the ride's position is changing. It will also tell you the direction in which the ride is moving. One can use a stopwatch to help calculate velocity. To find the average velocity, divide the displacement by the change in time. The formula is  $V_{ave} = (x_f - x_i)/(t_f - t_i)$ .  $V_{ave}$  stands for the average velocity,  $x_f$  is the final horizontal position,  $x_i$  is the initial horizontal position,  $t_f$  is the final time, and  $t_i$  is the initial time. Our free-fall ride takes about 2.5 seconds to fall 30 meters so its average velocity is  $V_{ave} = (0 \text{ meters} - 30 \text{ meters})/(2.5 \text{ seconds} - 0 \text{ seconds}) = -12 \text{ meters/second}$ . The velocity is negative because the direction of motion is downward.

The difficulty is that part of the time the free-fall ride is moving slower than 12 meters/second and the rest of the time it is moving faster. In this case, one may also want to know the instantaneous velocity, which is the speed and direction of motion at an instant in time. If one had more position and time data points, one could plot these ordered pairs on graph paper. The slope of a line drawn between any two points on the resulting curve is the average velocity of the car moving between the two positions. The instantaneous velocity at any given time is the slope of the line tangent to the curve at that time.

### Acceleration

The rate at which velocity changes is called **acceleration**. The change can be in speed, direction, or both. For the free-fall ride, the acceleration is considered to be a constant of 9.8 meters/second<sup>2</sup> due to Earth's gravity. Thus, acceleration in a free-fall ride is a change in velocity. However, in a roller coaster, the acceleration in many instances is not just a change in speed caused by gravity. In some sections of the roller coaster, such as a loop-de-loop, the direction in which the roller coaster is moving also changes.





## Newton's First Law of Motion

An object at rest will stay at rest and an object in motion will stay in motion with the same velocity—speed and direction— unless acted upon by a net external force. One can determine if a force is acting on an object: It moves if it was at rest; it changes speed if it was in motion; or it changes direction. Often it is a change of motion that makes a ride so thrilling. Consider riding in an automobile. If one closes his or her eyes while the car travels at a steady rate, he or she can hardly tell it is moving. But one can definitely feel sudden stops, starts, or sharp turns. Amusement park rides capitalize on this by creating changes in motion to make the rides more exciting and interesting.

If it is the change in motion that makes a ride so much fun, one must wonder what causes these changes. What makes a ride speed up, slow down, or take a sharp curve? As Newton said, the answer is force.

### Forces

A **force**, simply put, is a push or a pull. Forces exist everywhere. When one throws a ball at a target and tries to win a stuffed animal, his or her arm pushes on the ball until it leaves the hand; that is a force. When one presses the acceleration pedal of a bumper car, the car moves forward and the seat pushes on the rider's body, another example of a force. Forces have both magnitude (size) and direction, as do displacement, velocity, and acceleration.

One can think of it this way. If a rider is in a bumper car traveling forward and someone bumps him or her from behind, the push or force is going in the same direction as the rider, so he or she would accelerate forward and speed up. If the rider gets a bump from the side, he or she may not speed up, but the car and the rider will change directions. In a head on collision the car may stop or it may bounce backwards, depending on the circumstances. In all these situations, the final outcome depends upon the amount of force and the direction of force. What do these examples have in common? An outside force applied to an object causes the object to accelerate. This is explained by Newton's second law of motion.

## Newton's Second Law of Motion

The greater the force on an object, the greater its acceleration, that is,  $F = ma$ , where  $F$  stands for force applied,  $a$  for acceleration, and  $m$  represents the mass of the object to which the force is applied.

### **Newton's First Law of Motion**

*An object at rest will stay at rest and an object in motion will stay in motion with the same velocity—speed and direction— unless acted upon by an unbalanced external force.*



**Newton's Second  
Law of Motion**

*The greater the force on an object, the greater its resulting acceleration.*

$$F = ma$$

To illustrate Newton's second law, one may use the bumper car ride for illustration. When car A hits car B, car A impacts with a force on B that is dependent on the mass and the change of speed (acceleration) of car A. If car A merely taps car B, car B will change speed or direction only slightly. If car A hits car B with a large amount of force, car B will increase speed and, depending on the direction of the hit, car B may move off in another direction.

Let's assume a rider and a bumper car have a combined mass of 175 kilograms (kg). Before the car even gets a chance to start moving, another car and rider having the same combined mass drives up from behind and hits the first car with a force of 350 newtons ((N) a unit of force). What is the resulting acceleration due to the force applied?

By applying the second law of motion,  $F = ma$ , one can solve for the acceleration (a)

$$a = F/m$$

$$a = 350 \text{ N}/175 \text{ kg} = 350 \text{ (kg} \cdot \text{meters/second}^2\text{)}/(175 \text{ kg}) \\ = 2.1 \text{ meters/second}^2$$

If the car is hit with a force of 525 N, the resulting acceleration is  $a = 525 \text{ N}/175 \text{ kg} = 525 \text{ (kg} \cdot \text{meters/second}^2\text{)}/(175 \text{ kg}) \\ = 3 \text{ meters/second}^2$

**Newton's Third Law of Motion**

For every action there is an equal and opposite reaction. Using the same bumper cars to illustrate Newton's third law of motion, if car A hits car B, the motion of both cars changes. This is because car A is not the only one exerting a force. Car B is exerting an equal and opposite force on car A. This opposite and equal force is Newton's third law of motion. Both the object exerting the force and the object that receives the force have changes in acceleration. This leads to a discussion of gravity and to Newton's law of universal gravitation.

**Gravity**

Remember that a force is a push or a pull. Gravity is a force that pulls all objects on Earth toward the Earth's center of mass. The force due to gravity is the reason that we walk on the ground, rather than bounce or float. Most people are not aware, however, that all objects have a gravitational pull to themselves. That means that everything, regardless of whether it is a feather, a cannon ball, or a star, is attracting everything toward its center of mass. Any object that has mass produces a gravitational pull toward its center.



## Newton's Law of Universal Gravitation

Any two objects have a force of attraction between them. Newton reasoned that the orbits of the planets were caused by the forces of attraction between the planets and the Sun, the gravitational force. The amount of gravitational pull depends on the **mass** of an object. The more massive the object, the stronger the pull. Earth is a huge mass with an enormous gravitational force, pulling everything toward its center. Because the gravitational pull one feels on Earth is so huge, one may not notice other pulls from smaller objects on Earth, which are negligible in comparison and are not strong enough to overcome friction.

Earth's mass creates a gravitational field that attracts objects with a force inversely proportional to the square of the distance between the center of the object and the center of Earth and is shown in the equation  $F_G = Gm_E m_o / r^2$ .  $F_G$  is the gravitational force,  $G$  is the universal gravitational constant,  $m_E$  is the mass of Earth,  $m_o$  is the mass of the object, and  $r$  is the distance between the centers of Earth and the object. At the surface of Earth, the acceleration due to gravity is approximately 9.8 meters/second<sup>2</sup>. This acceleration is called 1 **g** or 1 Earth gravity. Using the same giant ruler reference frame, 1 **g** = -9.8 meters/second<sup>2</sup>. The sign is negative because the acceleration is inward toward the center of Earth, or downward.

Massive bodies, such as planets, moons, and stars, exert different sizes of forces of gravity on an object, depending on the masses and the distances between the objects. The Moon, for instance, has one-fourth the radius of Earth, 1.2 percent of Earth's mass, and has one-sixth as much gravity as Earth. The Sun could hypothetically hold 1 million Earths and has an immense gravitational pull. This explains why the planets in our solar system orbit the Sun.

Remember that gravitational pull is a two way street. Just as Earth pulls on the Moon, the Moon pulls on Earth. The tides on Earth are caused by the gravitational pull of the Moon and the Sun. Even though the Sun is comparatively farther away than the Moon, it is much more massive. The effect on the tides of Earth is the greatest when the Moon and the Sun are on the same side of the Earth and in a straight line with respect to each other.

### **Newton's Law of Universal Gravitation**

*All objects have a force of attraction among them that is proportional to the product of their masses and inversely proportional to the square of the distance between them.*



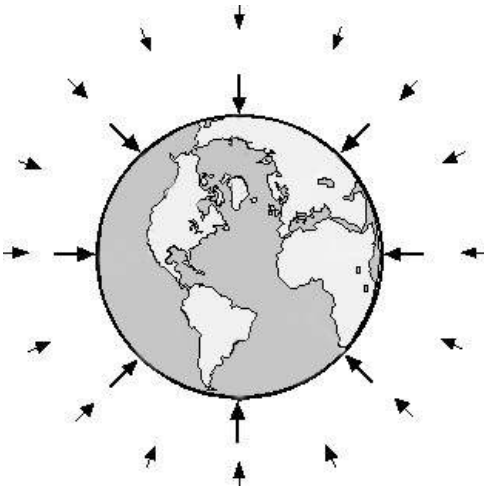

Earth's gravitational field pulls objects toward its center. At Earth's surface, this force causes an acceleration of 1 g. As a person or object travels farther away from Earth's surface, the smaller the effect of the gravitational pull on that person or object becomes.

### Actual Weight and Apparent Weight

#### Actual Weight

$W = mg$ , where  $W$  is the actual weight,  $m$  is the mass of the object, and  $g$  is the acceleration of gravity. This acceleration on Earth's surface equals  $-9.8 \text{ meters/second}^2$ .

#### Apparent Weight

$P = ma - W$ , where  $P$  is the apparent weight,  $m$  is the object's mass, and  $a$  is the net sum of accelerations acting on the object, other than gravity.

## Weighing in on Gravity

As a rider plummets to the ground on a free-fall ride, he or she may feel like he or she weighs less than usual, without any change of body size. How is this explained? Understanding the difference between weight and mass is an important next step.

Mass is a fundamental property of all matter and can be thought of as the amount of "stuff" that makes up an object. Two scoops of ice cream could be exactly the same size, but one of them could have more mass than the other. The ice cream with more mass is made of more stuff, or molecules. It could have less air mixed in with it, or have thick, dense fudge swirled through it to give it more mass than the other scoop.

For any given object, mass is constant but weight is not. Weight is affected by both the mass and the gravitational pull. When people weigh themselves, they step on a scale, compressing a spring or other device inside. It compresses because gravity is attracting and pulling the person downward, creating a push on the spring. The more massive a person is, the more the person weighs, therefore causing the spring to compress more than for less massive people. If the gravitational pull of Earth suddenly became weaker, everyone and everything would weigh less. That is because the spring inside the scale would compress less. This happens even though their masses have not changed. Weight is both a measure of gravitational force and the amount of mass of the object. The actual weight is a result of the force that the existing gravity imparts onto you.

If an object were weighed on the Moon, the weight would appear to be one-sixth of what it is on Earth, although its mass would not have changed. The Moon has one-sixth the amount of Earth's gravity. Therefore, a 445-newton (100-pound) person would weigh 74.2 newtons or 16.6 pounds on the Moon.

So, even though one may feel lighter on a certain ride, it is not because the gravitational pull of Earth is changing. The rider's actual weight is not changing, but his or her apparent weight is changing. One's apparent weight may be either larger or smaller than the actual weight.

The Earth's gravity, for small distances above and below the Earth's surface, can be considered constant. Also, one's mass, for the most part, does not change, at least not during the time one spends at the amusement park. Of course, a



huge intake of food items can change one's mass slightly. Then, what causes a person to be pressed sharply into his or her seat on a roller coaster (greater than one's actual weight), or to feel lighter on a ride (less than one's actual weight)? The reason that one's apparent weight changes may be due to a variety of forces acting on the person or object.

### The Energy of Motion

**Potential energy (PE)** is a stored form of energy that can produce motion, that is, the potential for motion. The Earth's gravitational attraction can be used as a source of PE. When the roller coaster car is at the top of the highest hill, it has the greatest amount of gravitational PE for the ride.  $PE_{(grav)} = mgy$ , where  $mg$  represents the weight of the car and its occupants, and  $y$  represents the height in meters. Using the reference frame that was used previously, the downward displacement of an object results in a decrease in PE.

**Kinetic energy (KE)** is a form of energy related to an object's motion.  $KE = (1/2)mv^2$ , where  $m$  is the mass (Kg) of the car and its occupants and  $v$  is the velocity (m/s) of the car. If the mass of two objects are equal, then the object having the higher speed or velocity will have more KE than the other. The roller coaster car's kinetic and potential energies change as the car moves along the track. The sum of the two is called the total mechanical energy of the car. If gravity is the only force acting on the car, then the total mechanical energy is constant. This is referred to as the law of conservation of mechanical energy.

In most real-life situations, however, friction and air resistance are present also. As the roller coaster falls, only part of its potential energy is converted to KE. Due to air resistance and friction, the part of the PE that is not converted to KE is converted to heat energy and possibly sound energy too. In these cases, the law of conservation of mechanical energy does not hold true because the sum of the PE and KE are not constant throughout the ride. Sometimes there are situations where the friction and air resistance are negligible, such as when the moving object is very dense and rolling on a smooth surface, and they can be ignored. For purposes of simplicity in this guide, friction and air resistance will be ignored, and it will be assumed that the law of conservation of mechanical energy is true for the amusement park rides.

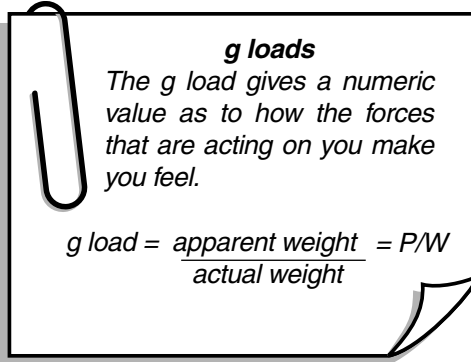

**g loads**  
The g load gives a numeric value as to how the forces that are acting on you make you feel.

$$g \text{ load} = \frac{\text{apparent weight}}{\text{actual weight}} = P/W$$

**Puzzler**

You are riding around the curve of a roller coaster, and your accelerometer reads 3 g. As you go down the hill, the accelerometer reads 0 g.

**Q:** Does this mean the Earth's gravity changes on the roller coaster?

**A:** No. Although the gravitational force changes as the vertical distance changes, for small distances, such as those for a roller coaster, it is considered to be constant. There must be other forces that are affecting the reading. The accelerometer is registering changes in acceleration, which in this case, happens to be measured in g units.



## Parabolic Path of Low-Gravity Research Aircraft

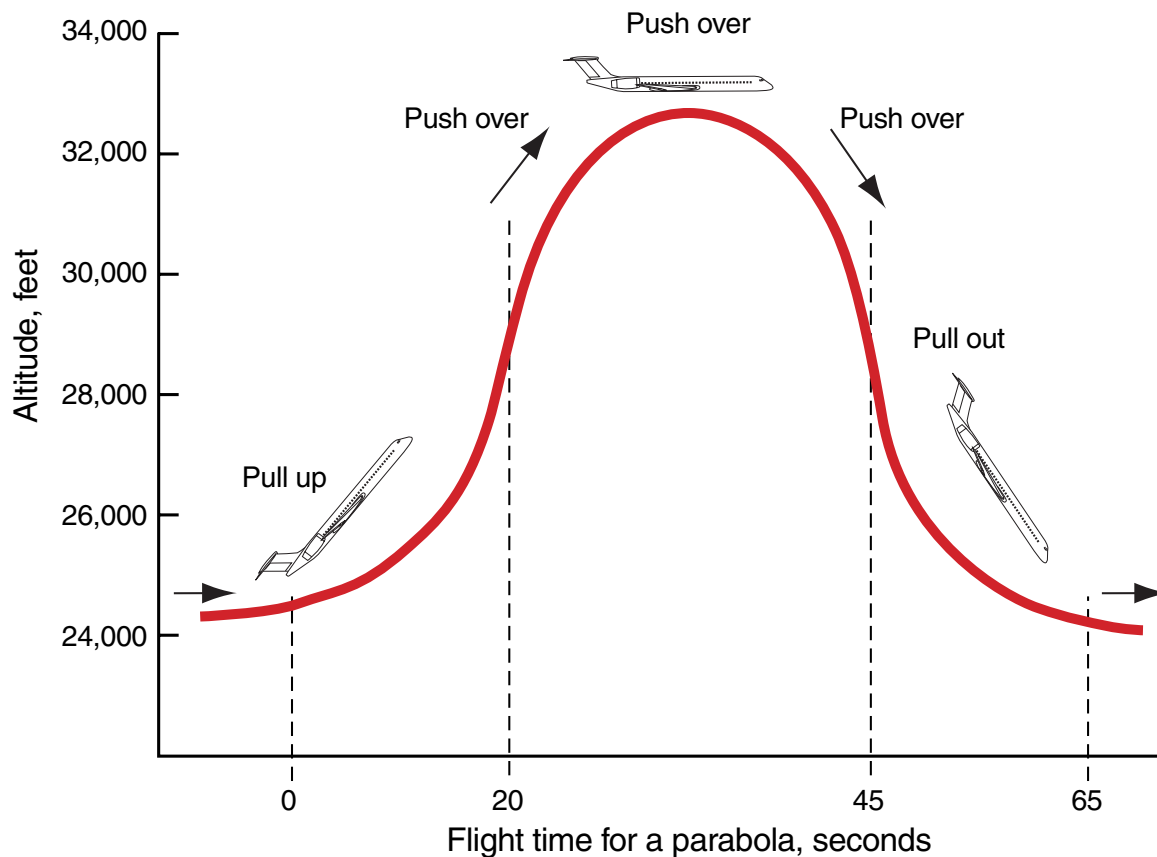

### Microgravity at the Amusement Park

You will definitely feel microgravity conditions at the amusement park, because your apparent weight may feel less than your actual weight at times. The sudden changes in motion create this effect. We can now define microgravity more precisely than we did previously to be “an environment where your apparent weight is less than your actual weight.” At the park the key to this condition is free fall. Think of a steep roller coaster hill. Gravity pulls the coaster car down towards the center of Earth. When not in the state of free fall, between the coaster and the ground is a rail that pushes up on the car to keep the coaster from falling to the ground. When it is in free fall, however, there is no vertical support needed. As long as the rail is curved in a parabolic shape and the car is moving at the correct speed, the car and its riders are in free fall.

What would happen if you were not strapped in? Maybe a ride on a special airplane can provide some answers. The KC-135 jet is a research aircraft that NASA uses to create microgravity conditions. This aircraft creates microgravity conditions by flying in steep arcs, or parabolas (see diagram). It has padded walls, foot restraints, handholds, and devices for securing the experiments during flight. During research flights, the KC-135 can fly 40 to 60 parabolas, each lasting for 60 to 65 seconds. First, the plane climbs at a  $45^\circ$  angle to the horizon. This is called a pull up. Then the pilot slows the engines so that they just make up for the air resistance or drag. The plane and everything that is inside coasts up over the top, then down, in a steep curve, a parabola. This is called a push over. The plane then descends at a  $45^\circ$  angle to the horizon, called a pull out. As the plane starts to dive, the pilot increases the power on the engine, then arcs up to repeat the



## NASA Drop Towers Compared With Cedar Point Amusement Park Attractions

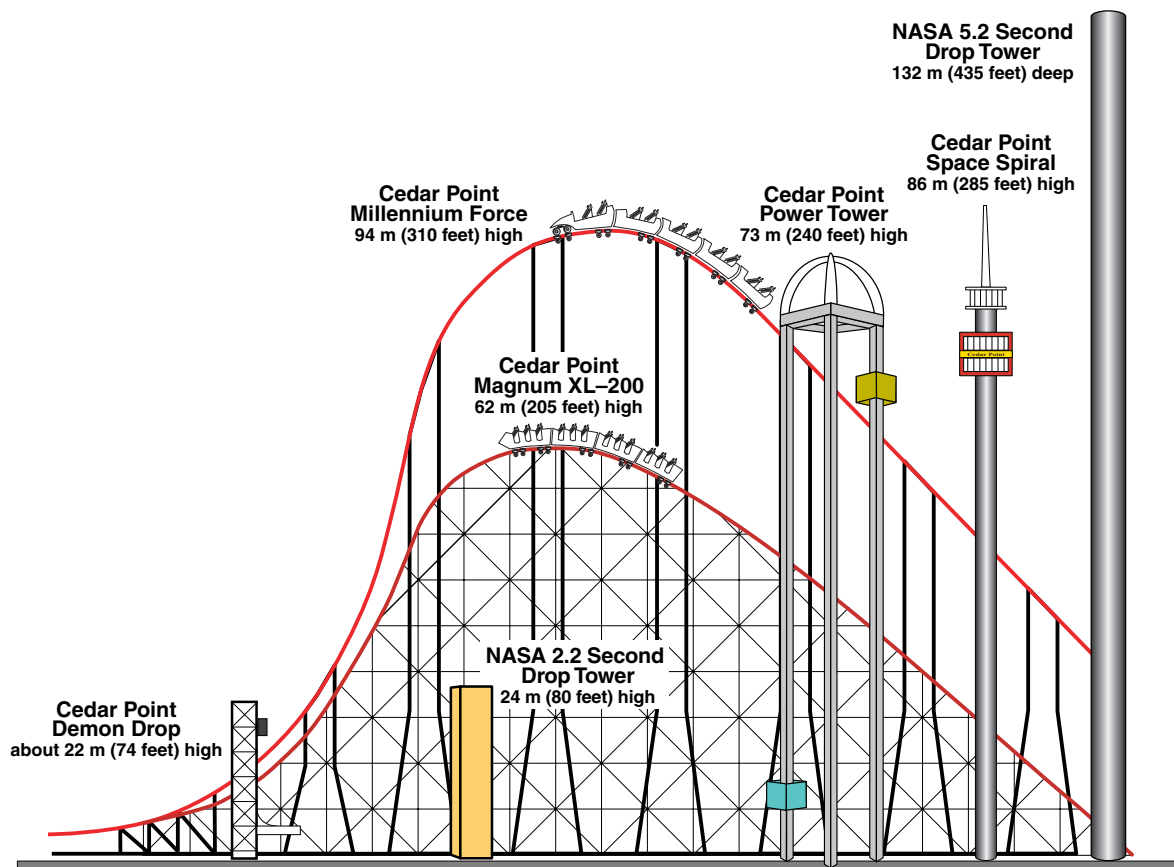

process. During the pull-up and pull-out segments, the crew and the experiments experience accelerations of about 2 g. During the parabola trace, the net accelerations drop as low as 0.015 g (nearly 0 g) for about 20 to 25 seconds. Reduced-gravity conditions created by the same type of parabolic motion can be experienced on “floater” hills of roller coaster rides.

### Low g or Microgravity

Microgravity conditions can be due to a reduction of gravitational forces or an acceleration toward the Earth’s surface. The first method is not an option if we are staying on Earth.

A free-fall ride, however, can provide a rider a great on-Earth microgravity experience. If one could stand or sit on a scale during this ride, it would show that he or she would weigh less than normal. Remember the spring in the scale? In order for the scale to read a person’s weight, the spring must be compressed by a force. Because the scale would be falling right along with the rider as the car is falling, there would be no downward force to compress the spring even if it were directly underneath the person. Instead of using a scale to register weight, a vertical accelerometer can be used to measure the g loads experienced during the ride.

Outside of the amusement park, free fall is not all fun and games. NASA facilities, called drop towers, operate like the free-fall rides, taking full advantage of the acceleration of gravity in order to create microgravity conditions. These towers are used by scientists to study everything from



combustion to fluids, to experimental designs. The NASA Glenn Research Center has two drop facilities. One provides a 132-meter drop into a hole in the ground creating a microgravity environment for 5.2 seconds. The other facility, a 24-meter tower, allows for 2.2 seconds of microgravity. One can experience falling by riding on drop rides such as the Demon Drop (22 meters high) and the Power Tower (73 meters high). Both of these rides are at the Cedar Point Amusement Park in Sandusky, Ohio.

The longest drop time available to researchers at this time is 10 seconds, achieved at a 490-meter underground drop shaft in Japan. This drop tower, which is deeper than the Empire State Building is tall, has a drop distance of 381 meters or 1250 feet!

An ideal microgravity environment for research is in the Earth's orbit. A main difference between an orbiting spacecraft, such as the space shuttle, the International Space Station, and the drop towers is the length of time for the microgravity condition. The similarity is that the microgravity condition is achieved the same way in orbit as it is in the drop towers or even the drop rides at the amusement park—by free fall. It is a common misconception that astronauts float around in the shuttle because there is no gravity in space. What really makes them float is the fact that spacecraft, and the astronauts in it, are falling around Earth.

High-g Loads	
Washing machine spin cycle	up to 163 g
Fighter jet	up to 10 g
Loop roller coasters	up to 3.7 g
Shuttle takeoff	up to 3 g
Commercial aircraft on takeoff	up to 1.5 g

### High-g Loads

The gravitational pull towards Earth never changes. However, just as weightless sensations can be created by certain motions on Earth, so can the feeling of heaviness. When a person's apparent weight is heavier than his or her actual weight, he or she is experiencing what is called **high-g** forces. These high-g forces can happen because of an increase in gravitational force, an acceleration away from Earth, or horizontal circular motions. One doesn't have to look too far at the amusement park to find high-g force experiences. On the roller coaster the rider feels pressed into his or her seat as the car hits the bottom of a hill or bends around a sharp curve. Some free-fall rides shoot up into the air, in which case the rider feels as if he or she is getting pushed into his or her seat. One feels high-g forces in these situations because the direction and/or speed of the ride is changing in just the right way.





Loop-de-loop coasters rarely exceed 3.7 g. This may sound like fun, but for most people these g loads are more than enough excitement. Accelerating at 9 or 10 g in the wrong direction can cause the blood (which carries needed oxygen) to drain from a person's head resulting in tunnel vision and unconsciousness. If the curves of a roller coaster can make you feel weighted down, imagine flying a military high-speed aircraft. These jets are built to withstand up to 10 g. Pilots train to pull 4 to 5 g. Sometimes fighter pilots must handle as many as 10-g loads. How do they avoid passing out? Fighter plane seats are inclined back to prevent blood from draining from the head. Pilots also wear vests and leg straps with rubber air bladders that automatically inflate to create pressure on the body to force blood back to the brain. Also, grunting by the pilots tightens the stomach muscles which helps to bring oxygen back to the brain.

During the space shuttle's liftoff, until it reaches orbit astronauts experience different g levels. As the space shuttle takes off, astronauts experience around 1.6 g. During the first 4 seconds of ascent, the shuttle accelerates from 0 to 100 mph! From that point until the solid rocket boosters burn out (2 minutes after launch) the accelerations can be as great as 2.5 g. When the solid rocket boosters are jettisoned, the acceleration drops dramatically to about 0.9 g. As the liquid fuel in the engine burns, the vehicle lightens and the acceleration slowly increases to 3 g. This acceleration causes astronauts to experience a push back into the seat that feels several times stronger than a commercial airliner takeoff.

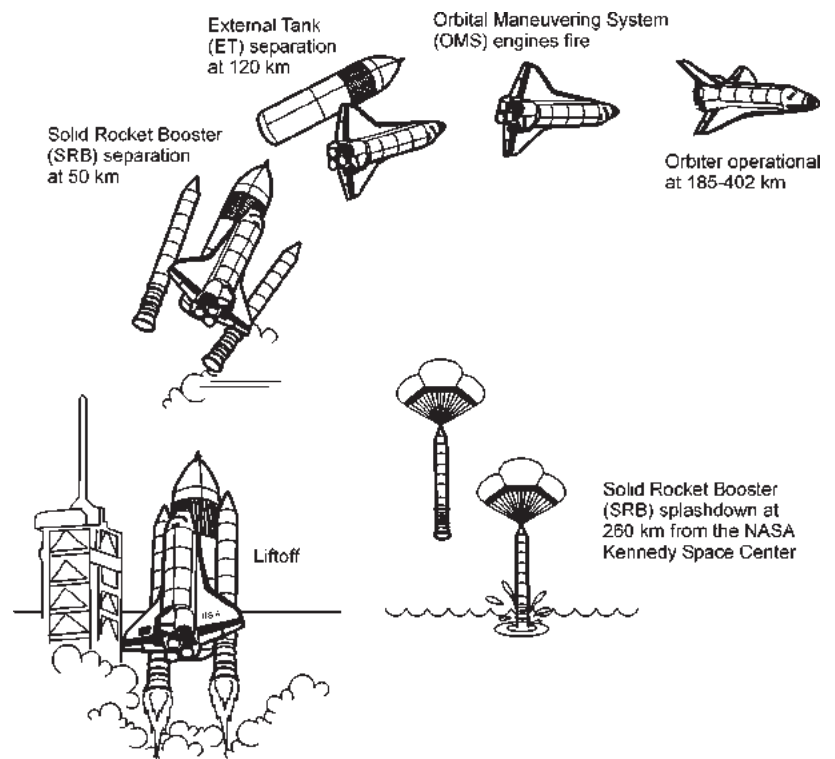

### Circular Motion

It is easy to feel high g when circular motion is involved. The clothes in the spin cycle of a washing machine can experience as high as 163 g! In the loop-de-loop roller coaster the riders travel in a curved path. They feel heavy because they are being pressed against the seat, similar to the clothes that get pressed against the walls of the washing machine during the spin cycle. During the turns, it is hard for the rider to lift his or her head from the head rest of the car. The same experience that happens to the rider happens to the clothes in the washing machine, only the acceleration in the coaster is not as high. While moving in a loop, the acceleration gives you the sensation of high g. The rider's inertia causes him or her to keep moving in a straight line (Newton's first law of motion), but the roller coaster car and the track forces the rider to change directions.



## Basic Skills

Students who go to the park without mastering the following skills have difficulty completing the ride worksheets in the next section. To have a successful physics day experience at the amusement park, students need to

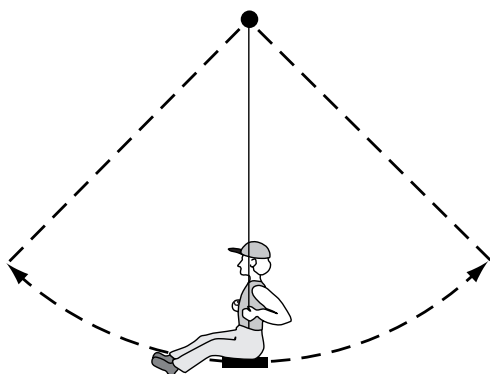

*A vibration is one back-and-forth motion.*

1. Practice and successfully use a stopwatch to time rides.
2. Know how many average steps to take to walk 30 meters.
3. Measure eye level height.
4. Practice using the altitude tracker and accelerometer.
5. Practice and master two methods for estimating heights.
6. Review how to calculate average times, average speed, how to correctly use the Pythagorean theorem, and how to use the equation for finding the period of a pendulum.

### Time

Time is an important measurement for calculating speed and acceleration. Students can use stopwatches to time a ride's duration, portions of rides, or a series of movements to calculate the average ride speeds. Stopwatches and digital watches with stopwatch features are the best. Digital and analog watches with second hands may work well with high school students. Students need practice taking several readings to improve accuracy and get practice calculating average times and speeds.

For fast movements it sometimes is easier to time a series and divide to find the single motion. For example, a student gets on a swing and has established a consistent arc. The partner times the rider for 30 seconds and counts the number of **vibrations** (one vibration is a back-and-forth movement). The partner can then divide the time, in seconds, by the total number of vibrations to calculate the **period** (period = time/number of vibrations).

### Distance

At the amusement park, one cannot interfere with the normal operation of the rides, such as jumping gates and shrubbery to measure ride diameters and distances. Measuring the length of a normal step is a relatively reliable way to gauge distances. Many of the ride worksheets require measuring hill distances or using baselines for angle measurements to calculate ride heights. Use a metric measuring tape or meter stick to mark 10 meters in a hallway or parking lot, with strips of masking tape or chalk. Students can practice walking this distance and counting their steps. Each step counts as one. Have students determine the average number of steps they



*These students are finding the average number of steps they take to walk in 30 meters along a hallway in their school.*



take after three or four trials. As a class, review how many steps they would need to take to walk 10 meters and what to do to calculate 30 meters. Students should record this number in a safe place so they do not forget. See the Forms and Extras section for the Eye Level Height and Stepping Estimation Record.

## Eye Level Height

In order to calculate the height of amusement park rides, students need to know the distance from the ground to their eye level. Once students have determined the height of a ride, they should factor in their eye level height for greater accuracy. The altitude trackers measure the height of the ride from eye level, rather than from the ground. Before going to the park, each student should measure his or her own eye level height and record this information for safe keeping. Students will need this measurement with them at the park.

### Preparation

Set up stations around the classroom for your students to measure their eye level. Tape meter sticks vertically on the wall with the bottom of the stick 1 meter above the floor. Be sure the “0” is located at the 1-meter position. This makes the top of the stick 2 meters above the ground. Caution, students usually overestimate eye level height, moving their hand up instead of straight across. Be sure to mention this and demonstrate how to avoid this error.

### Procedure

1. Demonstrate how to take an accurate measurement of eye level height. It is important for their line of sight to be parallel to the ground. Using a ruler to sight along while finding measurements can be helpful.
2. Have students work in pairs, taking turns helping each other measure individual eye level at the stations around the room. Have them record the number on paper.
3. Remind students to add 100 centimeters to their measurement. For example, if a student reads their eye level height as 53 centimeters on the meter stick, then the eye level height is 153 centimeters. Convert this to meters, rounding to the nearest 1/10. In this case, eye level height is 1.5 meters. Have students write their eye level height in their notebooks.
4. Keep a master list for all students. (See the Forms and Extras section for the teacher master list of eye level height and stepping estimation.)

### Materials

- 1-meter stick
- Masking tape
- Ruler (optional)

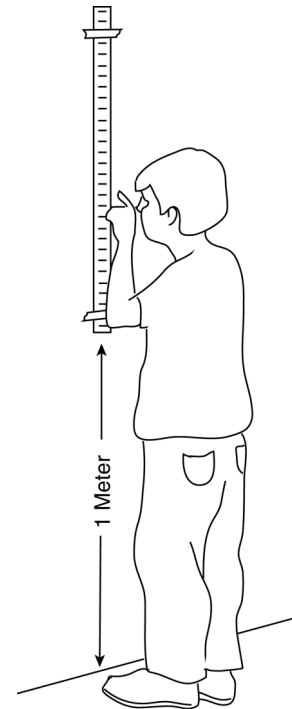

*To measure eye level height, sight horizontally onto a meter stick.*

**Note to teachers:** Don't forget to record your eye level height as well.



*Students work in teams to take accurate eye level measurements.*



### Materials (per student pair)

- Cardboard or file folders (6 by 8 inches)
- Altitude tracker template
- 6-inch dental floss
- One washer
- One straw
- Glue
- Scissors
- Clear tape
- Push pin

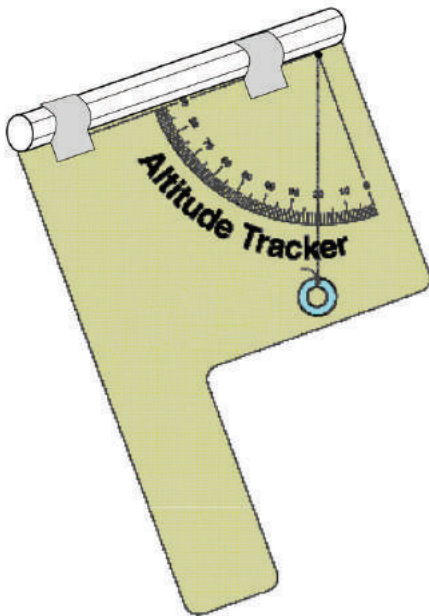

*The altitude tracker.*

## Altitude Tracker

To assemble sturdy altitude trackers that will withstand a trip to the amusement park follow the directions below. It is recommended that students work in pairs or groups of four at the park. In this case, the teacher will need enough supplies so each team of students has one tracker. If the teacher chooses to have the students work in a different size group, then adjust the materials accordingly.

### Procedure for building the tracker

1. Glue either the right-handed or left-handed altitude tracker template to the cardboard.
2. Cut out the template attached to the cardboard.
3. Glue the left-handed altitude tracker template to the other side of the cardboard.
4. Use the push pin to make a hole through the dots at the upper corners of the degree markings.
5. Tie one end of the dental floss to the washer.
6. Tie the other end of the dental floss through the hole in the template. The dental floss needs to hang down long enough so that the washer lies beneath the words "Altitude Tracker" and above the lower edge of the cardboard. If the dental floss is too long, the washer cannot swing freely while you hold the handle of the tracker and it will not work properly.
7. Tape the straw to the top of the tracker. Position the straw between the 90° line and the top edge of the tracker. Trim the straw so that the ends of the straw do not hang over either end of the tracker.
8. To prevent the dental floss from tangling while transporting, tape the washer to one side of the tracker.



*Students practice how to use the altitude tracker by measuring the height of a flagpole outside their school.*



Tape straw between line and edge.

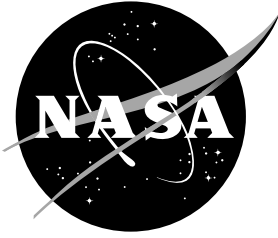

NASA Amusement Park  
Physics Day

This altitude tracker  
belongs to \_\_\_\_\_

Eye level \_\_\_\_\_ meters  
30 meters = \_\_\_\_\_ of my steps

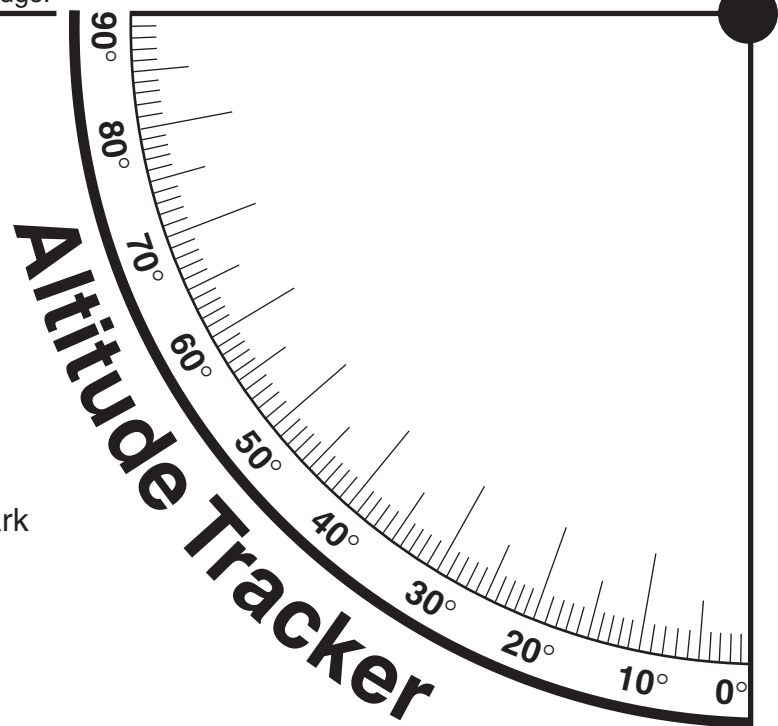

### Right-Handed Template Using the Tracker

1. Hold the tracker by the handle and look through the straw, sighting to the top of the object whose height you want to measure.
2. Let the washer hang freely, waiting until it stops moving.
3. With your free hand, tightly hold the washer against the cardboard to keep it still.
4. Have a partner read the angle measurement and record.



Tape straw between line and edge.

**Altitude Tracker**

NASA Amusement Park  
Physics Day

This altitude tracker  
belongs to \_\_\_\_\_

Eye level \_\_\_\_\_ meters  
30 meters = \_\_\_\_\_ of my steps

**Left-Handed Template  
Using the Tracker**

1. Hold the tracker by the handle and look through the straw, sighting to the top of the object whose height you want to measure.
2. Let the washer hang freely, waiting until it stops moving.
3. With your free hand, tightly hold the washer against the cardboard to keep it still.
4. Have a partner read the angle measurement and record.



## Altitude Estimation Methods

There are several techniques that can be used to estimate the height or altitude of rides. However, for the ride worksheets in this guide, students are asked to use two methods: scale drawing and structure estimation.

### Scale Drawing Method

This method uses angles and a baseline to create a scale drawing. To use this method, students need to know their eye level height, the number of steps they take to walk 30 meters, and how to use the altitude tracker. They take angle measurements from any arbitrary distance (they don't need to know this distance) and then they step 30 meters directly away, on the same line, from the ride and take another angle measurement.

### Procedure

1. Choose a distance to stand away from the ride so that the top of the ride can be clearly seen. It is not important to know how far from the base of the ride this distance is located. Use the altitude tracker to site the top of the ride and read the angle. The distance can be any convenient distance away. Draw the angle at the first position on the dotted line. Use a protractor to measure that angle, then label the angle with the correct degrees.
2. Step 30 meters away from the ride, directly in line with the first angle measure location and the ride. Draw a line away from the first position (to the right). The line should be drawn to scale. Using a scale of 1 centimeter = 10 meters, the baseline of 30 meters is 3 centimeters.
3. Take a second angle reading at this location. Draw, measure, and label the second angle.
4. Using a sharp pencil, carefully extend the lines of the angles so that they intersect. Mark a point at the intersection of the lines.
5. Draw a perpendicular segment from the marked point to the extended base line. (The extended baseline is shown as a dashed line in the drawings.) Measure this line and record the length next to the segment.
6. Convert this measurement from centimeters to meters.
7. Add the height of your eye level to this number to find the total ride height.

### Sample Scale Drawing for Altitude Estimation

Sample problem:  $\angle 1 = 28^\circ$ ,  $\angle 2 = 20^\circ$

$$\frac{3.4 \text{ cm} \times 10 \text{ m}}{1 \text{ cm}} = 34 \text{ m}$$

$$34 \text{ m} + 1.6 \text{ m (eye level height)} = 35.6 \text{ m}$$

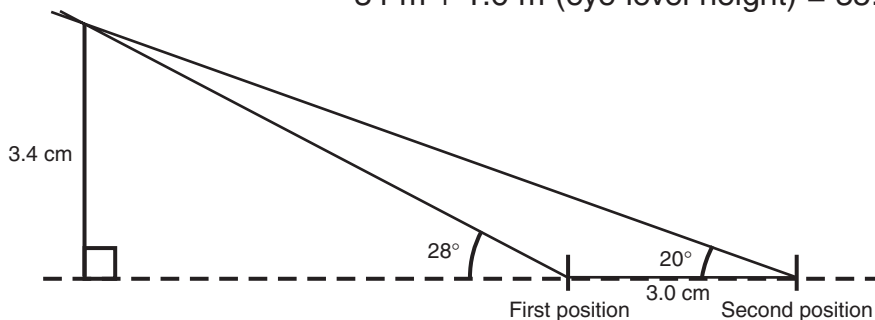

# Altitude Tracker Worksheet

## Procedure

Use a sharp pencil and a protractor to draw two angles 3 centimeters apart. Label the two angles. Find the point of intersection of the two rays of the angle. Draw a perpendicular line to the baseline from this intersection point to the extended baseline of the angles. Measure this distance in centimeters. Convert this number to meters using a scale of 1 centimeter = 10 meters. Add in an eye level height of 1.2 meters. See the example shown below.

Example:  $\angle 1 = 50^\circ$ ,  $\angle 2 = 35^\circ$

$$\begin{array}{r} 5.2 \text{ cm} \times 10 \text{ m} = 52.0 \text{ m} \\ + 1.2 \text{ m} \\ \hline 53.2 \text{ m} \end{array}$$

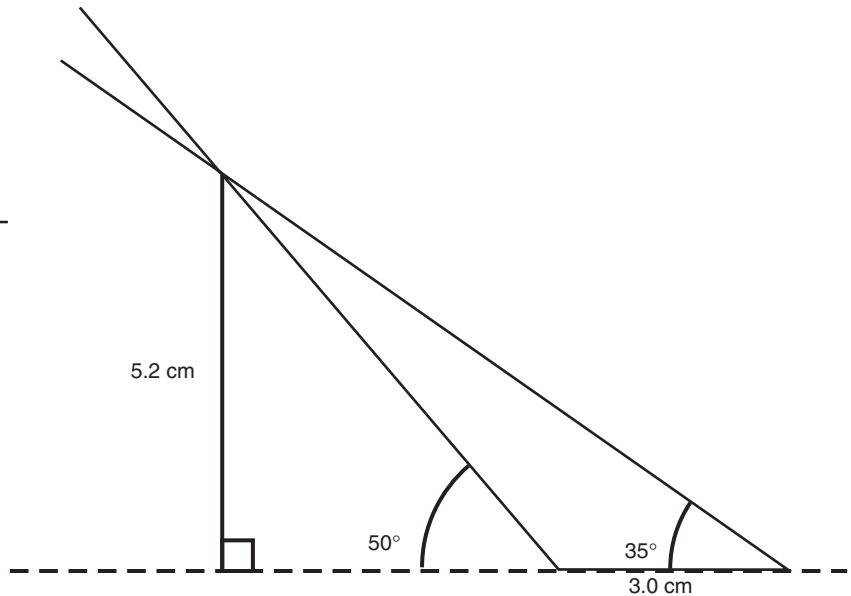

Determine the height of an object using the above procedure. Assume that the angles were measured using the altitude tracker.

1.  $\angle 1 = 60^\circ$ ,  $\angle 2 = 45^\circ$

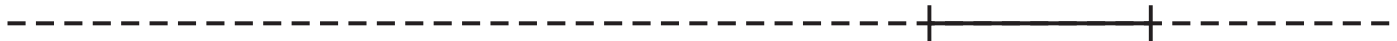

2.  $\angle 1 = 45^\circ$ ,  $\angle 2 = 20^\circ$





3.  $\angle 1 = 54^\circ$ ,  $\angle 2 = 30^\circ$



4.  $\angle 1 = 80^\circ$ ,  $\angle 2 = 55^\circ$



5.  $\angle 1 = 76^\circ$ ,  $\angle 2 = 58^\circ$



## Flagpole Height Worksheet

Measure the height of the school flagpole using the scale drawing method. See diagram shown. Use the space below to make your drawings.

1. Use the altitude tracker to site to the top of the flagpole and read the angle. Record the angle measure. \_\_\_\_\_
2. Draw the angle using the line segment at the bottom of the page. Use a protractor to measure the angle and label the angle.
3. Step 30 meters away from the flagpole.
4. Draw a baseline to represent 30 meters. The line should be drawn to scale. Using 1 centimeter = 10 meters, the baseline is 3 centimeters.
5. Measure the second angle and record its measure. \_\_\_\_\_
6. Draw and label the second angle.
7. Carefully extend the lines of the angles with a sharp pencil, until the lines intersect. Mark the intersection with a point.
8. Draw a perpendicular line from the point of intersection to the extended baseline. Measure and record this segment. \_\_\_\_\_
9. Convert the measurement from centimeters to meters. \_\_\_\_\_
10. Add your eye level height to find the total flagpole height. Write your final answer here. \_\_\_\_\_

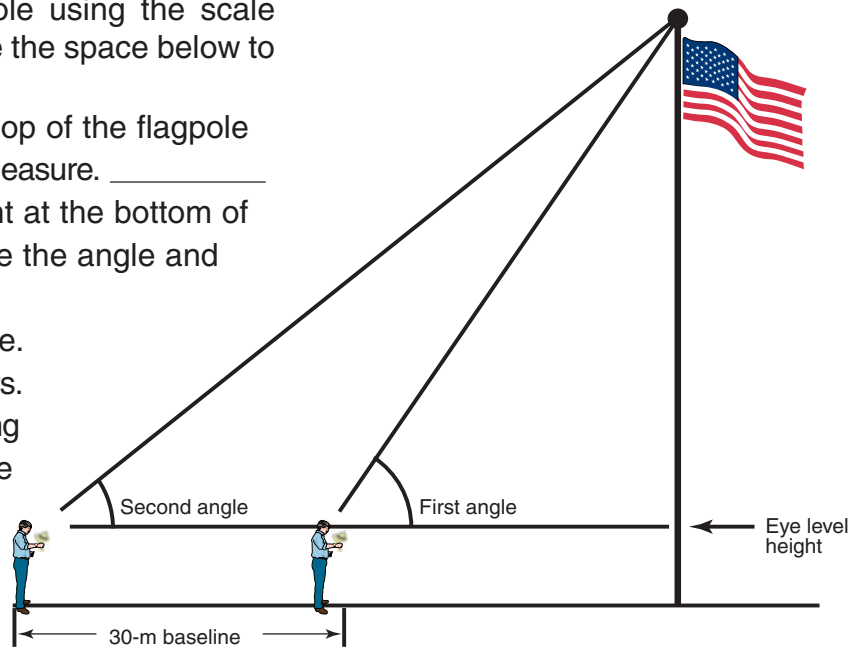



---

Draw your angles on this line segment.

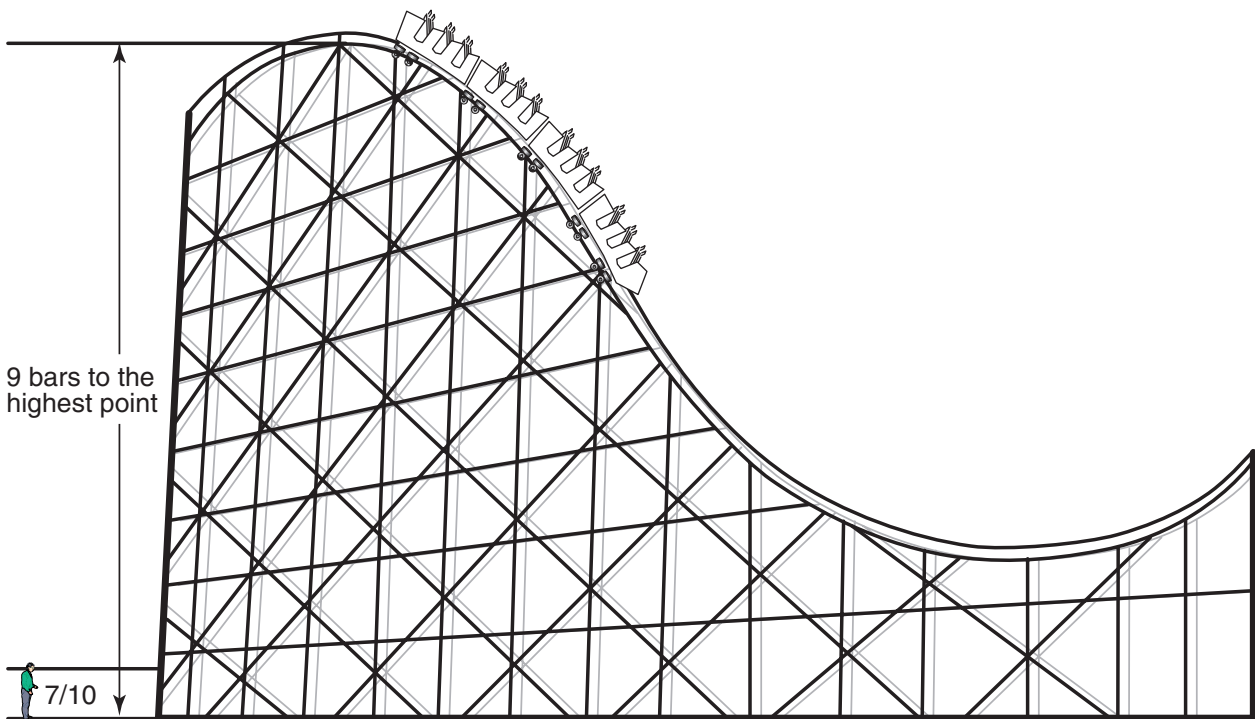

## Structure Estimation



This method allows students to estimate the height of a ride using support structures and proportions instead of geometry. Regular support structures are common on many amusement park rides. Students begin by estimating the height of the first support structure, relative to their eye level, and turn this into a fraction. They count the number of support structures between the ground and the top of the ride. Using multiplication and proportions, students can estimate the height of the ride with some accuracy.

In order to estimate the height of a structure, try to position yourself as close as possible to the structure base. Do not climb fences or cross into prohibited areas. The first thing to look for are regular support structures which have less height than the overall structure. The most accurate method is to estimate the height of the first support structure, and then count the number of supports between the ground and the top of the main structure.



## Procedure

1. Sight the height of your eye level to a target point on the first structure nearest the ground using the sighting tube on the altitude tracker. Be sure to hold the altitude tracker level aligned horizontally while doing this. Make note of the target point on the structure. This target point is your eye level height. See diagram shown.
2. Estimate the fraction of the target point to the height of the first support structure, to the nearest 1/10. This may take some practice to be able to do accurately. For example, in the diagram shown, a good estimate would be 7/10 the height of the first support structure. This fraction is called the span fraction.
3. Use formula  $H$  (support structure) = eye level height/span fraction to estimate the overall height of the support structure. In this example, if your eye level height was 1.4 meters, then  $H = 1.4 \text{ meters}/0.7 = 2 \text{ meters}$ , then you would have estimated the support structure to be 2 meters.
4. Count the number of these structures to the highest point and multiply the height, or  $H$ , by the number of structures. In this example, you would multiply 2 meters by 9 to get 18 meters in height.

Summarizing the measurements in the above example:

$$\begin{aligned} \text{The overall height of the ride} &= \text{number of structures} \times H \\ &= \text{number of structures} \times \\ &\quad \text{eye level height/span fraction} \\ &= 9 \times (1.4 \text{ meters}/0.7) \\ &= 9 \times 2 \text{ meters} \\ &= 18 \text{ meters} \end{aligned}$$

*Note: When calculating distances, students often progress through the steps without considering whether their final answer is reasonable. One might consider having them estimate the height of the school building by counting rows of bricks, and multiplying this number by the height of each brick. Have them compare this height to the height they computed for the flagpole. Ask them to determine, based on their calculations, which is taller, the school building or the flagpole? Is this a reasonable outcome?*



## Structure Estimation Worksheet

The following activity provides practice estimating height using the design structures of amusement park rides. Like bleachers in a stadium, many amusement park rides have parts that are evenly spaced. Roller coasters are an excellent example of this. If you can estimate the height of a horizontal support beam, you can make a good height estimate for a given part of a ride.

### Procedure

1. What is your eye level height? \_\_\_\_\_
2. Hold the altitude tracker level so that the angle reads "0" as you sight to the point marked by the dashed line (eye level height) in the figure below. (You are the figure in the diagram.)
3. What fraction of the height of the first structure is your eye level height (0.4, 0.5, 0.6 or 0.7)? \_\_\_\_\_  
This value is called the span fraction.
4. Estimate the height of the first structure by using the formula:  $H = \text{eye level height} / \text{span fraction}$ . \_\_\_\_\_  
\_\_\_\_\_
5. How many horizontal structures are on the coaster shown here? \_\_\_\_\_
6. Multiply the value you calculated in number 4 (estimated height of the first structure) by the number of horizontal structures present (see question 5) to estimate the total height of the hill. \_\_\_\_\_

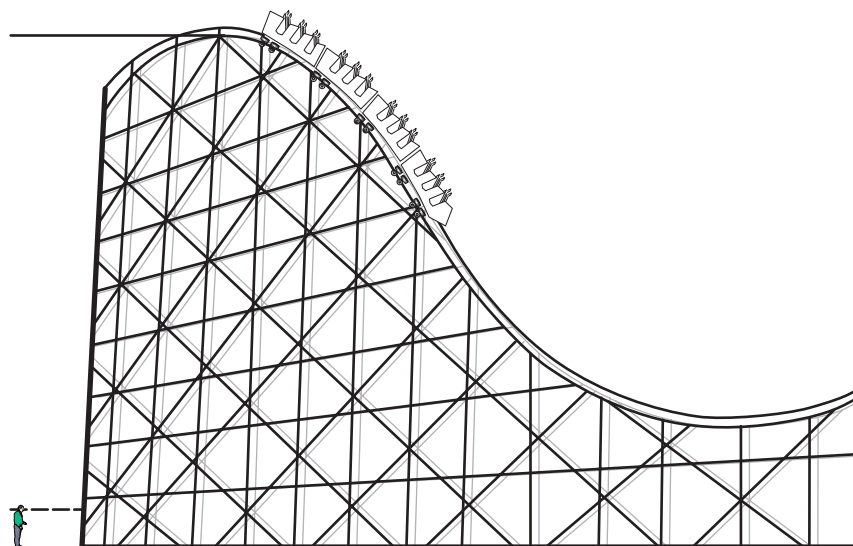

Use the structure estimation method you just used in the above example to estimate the height of the rides on the following page.



Use the box next to each picture to show your work.

Peak \_\_\_\_\_

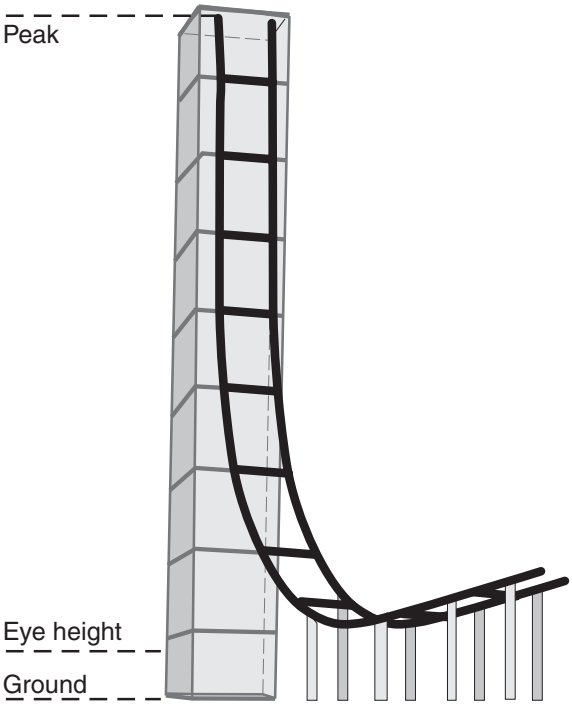

Eye level height \_\_\_\_\_

Span fraction \_\_\_\_\_

Estimate of first structure height \_\_\_\_\_

Eye height \_\_\_\_\_

Ground \_\_\_\_\_

Total number of structures \_\_\_\_\_

Estimate of total height of ride \_\_\_\_\_

Peak \_\_\_\_\_



Eye level height \_\_\_\_\_

Span fraction \_\_\_\_\_

Estimate of first structure height \_\_\_\_\_

Eye height \_\_\_\_\_

Ground \_\_\_\_\_

Total number of structures \_\_\_\_\_

Estimate of total height of ride \_\_\_\_\_



## Accelerometer

A vertical accelerometer is a simple tool that can measure the upward and downward accelerations of a ride in terms of Earth's gravity ( $g$ ). At rest, the accelerometer registers 1  $g$ , or normal Earth gravity. Earth's gravitational attraction will pull the spring to the 1- $g$  position. Measurements will range from  $-4$  to  $4$   $g$  on amusement park rides. You can make your own accelerometers by following these directions, or you can order an amusement park kit from a scientific supply catalog. Finding the tubes may present a problem, although thermometers are shipped in these tubes. If you plan to order a kit, allow plenty of time for delivery.

### Procedure-Spring-Mass Assembly

1. Attach the mass to one end of the spring. Be careful not to stretch the spring out of shape.
2. Bend the paper clip into a "V" shape, as shown in figure 1.
3. Poke two holes in one end cap, as shown in figure 2.
4. Thread the paper clip through the end of the spring without the weight, as shown in figure 3.
5. Thread the paper clip (with the spring and mass) through the holes inside the cap. Bend the wires down the cap sides. Trim the excess wire (see fig. 4).

### Calibration

1. Put the spring, mass, and cap into the tube. Hold the tube vertically (see fig. 5).
2. Carefully wrap the red tape around the tube level with the bottom of the weight. Use a narrow width of red tape. This marks the 1- $g$  position. At the top of the tube, draw a small upward arrow.
3. Remove the cap, mass, and spring from the tube.
4. Tie a second mass to the end of a string. Thread the other end of the string to the loop of the spring holding the first mass. Do not tie the string tightly because you will have to untie it shortly.
5. Replace the cap, spring, masses, and string through the tube. Be sure the tube has the arrow pointing up.
6. Wrap another narrow piece of red tape around the tube level with the bottom of the weight. This marks the 2- $g$  position (see fig. 6).
7. Remove the cap, masses, string, and spring from the tube. Untie the string/mass from the spring. Give the string/mass to the another pair of students for calibration.

### Materials (per student pair)

- Plastic thermometer tube
- Rubber band (large)
- Two end caps
- Two masses or fishing sinkers (1.5 ounces)
- Spring
- Red tape (1/8 inch)
- Paper clip
- Two pieces duct tape (1/2 inch)
- Push pin
- String (12 inches)
- Scissors
- Pliers
- Permanent marker

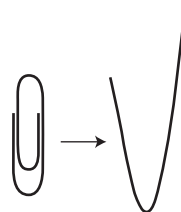

Figure 1.

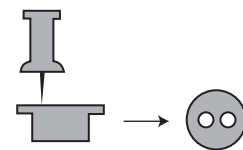

Figure 2.

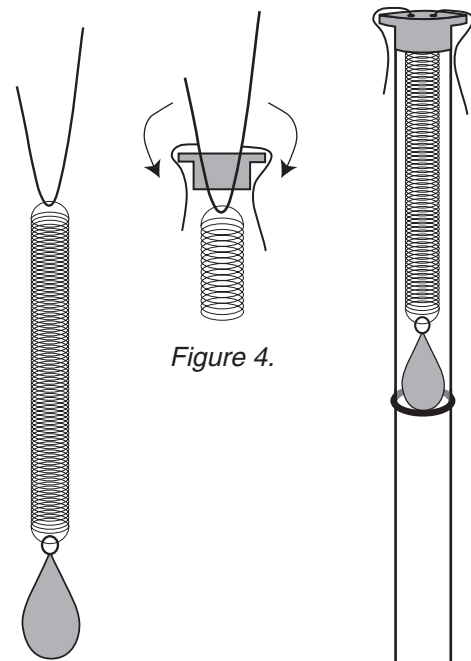

Figure 3.

Figure 4.

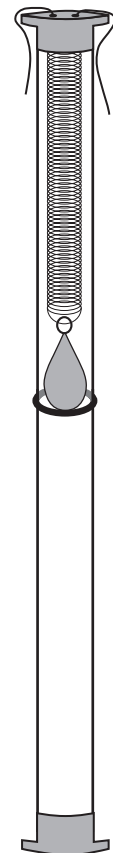

Figure 5.



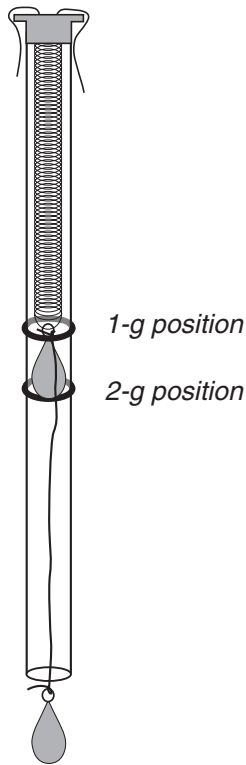

Figure 6.

8. Measure the distance between the two pieces of red tape. Measure from the top of both pieces of tape.
9. Use this distance to measure and mark positions for 0, 3, and 4 g with red tape (see fig. 7).
10. To make reading the g loads easier to see on the rides, number the marking. Write 0 to 4 on a strip of paper and tape them in place with white duct tape or masking tape. An alternative is to write the numbers on the sticky side of the tape with a permanent marker. Note, if possible, write the numbers 2 to 4 backwards.
11. Fully assemble the vertical accelerometer with both end caps and the spring-mass system in the tube.
12. Use duct tape to seal the end caps, cover the paper clip ends, and attach the rubber band tether to the tube (see fig. 8).

*Note: Amusement parks may have rules about what types of measuring devices, such as accelerometers, they will allow on rides. Be sure to call and check in advance. Most parks require a tether to be used with the devices for ride safety considerations.*

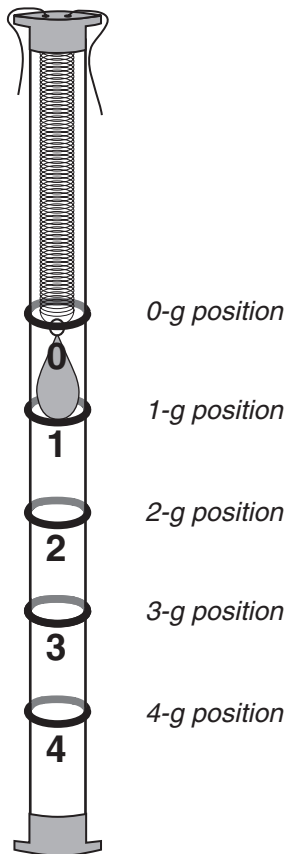

Figure 7.

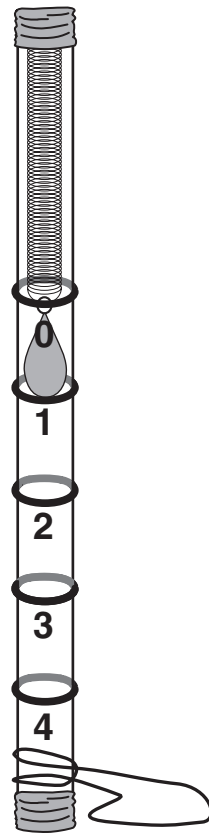

Figure 8.





## Errors in Measurement

Whenever something such as the thickness of a book or the length of a table is measured, there is always error involved in the measurement process. It doesn't mean that the person performing the measuring has measured it wrong. It is inherent in the measuring process. No measuring device is or can be 100 percent precise. For example, if one is using a ruler to measure length, and the smallest division on the ruler is  $\frac{1}{8}$  of an inch, the precision of that ruler is  $\frac{1}{8}$  of an inch. If the smallest division is  $\frac{1}{16}$  of an inch, then the precision is  $\frac{1}{16}$  of an inch. Notice that by dividing the ruler into more divisions, the greater the precision, but it can never measure anything perfectly. This is not possible for any measurement tool. For this to be so, the tool would have to have an infinite number of divisions. Because we are always limited to finite-scale measuring instruments, there will always be an associated uncertainty called error. Also, remember that if your ruler only measures with a precision of  $\frac{1}{8}$  of an inch, you cannot state that you found a length to the nearest  $\frac{1}{16}$ . Your measurement device will not allow you to have that high of a precision.

Since some tools have more divisions than others, some are more precise than others. Using more precise tools means that one's answer is a better estimate of the actual length, but it is still an estimate. At the amusement park, the tools used to perform these activities are not very precise. They only give a rough estimate of the actual measurements allowing the student to make observations and predictions based on patterns. The answer key and the measures and values that are found are also not exact. The teacher should expect to have answers that are in the range of those found in the key.

In some instances the student will be pacing to find some distances, using estimation of structures, and using eye level for height. Because they will not be using a standardized measurement device, such as a ruler, expect a large amount of error. Every time the student records a measurement, consider the possible sources of error. By increasing the number of times that he or she takes a measurement, the average or mean value of these measurements will more closely resemble the actual value of the quantity he or she is trying to measure assuming that the student used the tool correctly. This is because he or she is just as likely to measure a value that is slightly too high as one that is too low, therefore, these errors will "average themselves out."

If a value that is recorded involves an estimate that is to be multiplied with another estimated value, the error is multiplied also. This is called error propagation, and it can be significant especially when there are several steps of measurements multiplied within a problem. It cannot be avoided, but be aware that along with the measurements, the error continues to be multiplied and it is inherent in the final value.

As an example, if the students want to measure the base of a roller coaster hill, they would pace off the distance, using their pacing distance. If they estimate that two of their steps is about a meter in length, there is some error in this measurement. Also, they may not take the same size steps each time. So when they walk a 30-meter baseline, this error increases. However, the longer the distance, the more likely the short and long steps will average themselves out, thus giving them a better overall estimate. The use of the altitude tracker to measure the height of a structure can allow for more errors. Did they look through the same part of the hole; did they sight to the top of the structure at the same point each time—in other words, were they consistent when taking their measurements? This gives the student some idea of why there is no "exact" answer when taking measurements. Scientists and researchers always try to reduce the error as much as possible, but some error is always present.





# Classroom Activities



*Aligning the rulers for an angular collision of the marbles takes patience to set up properly.*



*Students make the second hill of their roller coaster using classroom items for support.*





## Pendulums—Part 1

Pendulums swing back and forth in a regular pattern. One back and forth movement is called a vibration. The time it takes to complete one vibration is called the period. This lab tests the effects of different lengths of string on the period of a pendulum swing.

### Task

Test what will happen to the period of a pendulum when the length of the string changes.

### Hypothesis

Predict how you think the string length will affect the period. (Will the period of the pendulum change when you change the length of the string?) Write your prediction here.

---



---



---

### Procedure

1. Tie the paperclip to the end of a string so that you have 1 meter of string length to work with, measuring from the middle of the paperclip. Allow enough extra string for tying.
2. Attach the top of the string to a ring stand or the edge of a table with tape so the paperclip can hang freely without touching the floor. Remeasure to make sure that the total length is 1 meter.
3. Hang the washer onto the paperclip and pull it to the side at a small angle and release.
4. Count the number of vibrations that occur in 30 seconds. A vibration is one swing out and back.
5. Do three trials and average the results.
6. Record your averages in the table on the next page.
7. Repeat steps 3 through 5, decreasing the string length by 10 centimeters each time. Continue for a total of 10 trials.
8. Make a coordinate graph of the results comparing the average number of vibrations in 30 seconds (y-axis) to the length of the pendulum string (x-axis).

**Don't forget to label!**

**Materials**

- Stopwatch
- 1-meter-long string
- One washer
- Meter stick
- Tape
- Paperclip
- Ring or support stand
- C-clamp

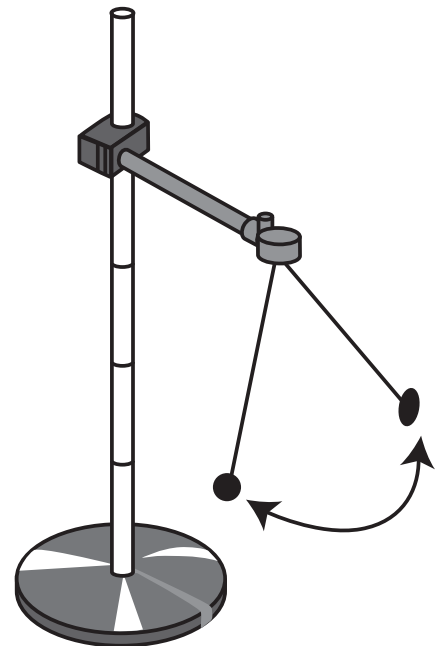



## Pendulums—Part 2

Pendulums swing back and forth in a regular pattern. One back-and-forth movement is called a vibration or oscillation. The time it takes to complete one vibration is called the period. This lab is going to test the effects of different masses on the period of a pendulum swing.

### Task

Test what will happen to the period of a pendulum when the mass attached to the string changes.

### Hypothesis

Predict how you think the mass attached to the pendulum will affect the period. (Will the period of the pendulum change when you change the mass attached to the string? If so, how? Will more mass cause the period to shorten or increase?) Write your prediction here.

---



---



---

### Procedure

1. Glue Velcro® to the outside of the lid of a film canister. Attach one end of a string to the Velcro®. Use enough string so that the total length from the bottom of the film canister to the point of attachment is 60 centimeters, allowing extra string for tying.
2. Tie the top of the string to a ring stand, support rod, or the edge of a table so that the canister can hang freely without touching the floor.
3. Put a washer inside the canister and close the lid. Pull the canister to the side at a small angle and release.
4. As the canister (with the washer inside) swings, count the number of vibrations that occur in 30 seconds. A vibration is one out and back swing.
5. Do this three times and average your results.
6. Record each average in the table on the next page.
7. Repeat steps 3 through 5, adding another washer each time to the canister. Continue for a total of 10 trials.
8. Make a coordinate graph of the results comparing number of vibrations that occur in 30 seconds (y-axis) to the number of washers (x-axis). **Don't forget to label!**

### Materials

- Stopwatch
- 60-centimeter-long string
- 10 washers or masses
- Meter stick
- Tape
- Film canister
- Ring or support stand
- C-clamp
- Velcro®

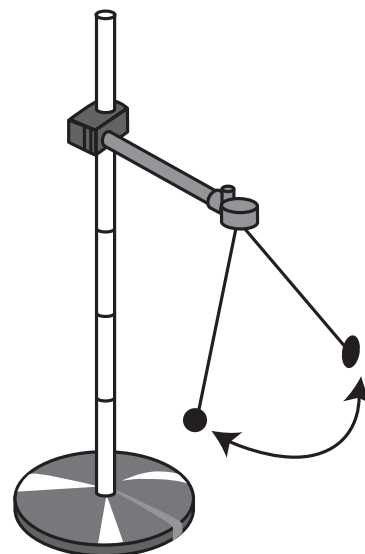

*Students measure the length of their pendulum.*



Number of washers	1	2	3	4	5	6	7	8	9	10
Average number of vibrations in 30 seconds										

Title: \_\_\_\_\_

**Conclusion** (Write answers in complete sentences.)

1. What effect does the mass attached to the string have on the period of a pendulum?

\_\_\_\_\_

\_\_\_\_\_

\_\_\_\_\_

\_\_\_\_\_

2. Two grandfather clocks are built at factories across town from each other. One is made of bronze and one is made of plastic. Is it possible for the two clocks to keep the same time? Explain.

\_\_\_\_\_

\_\_\_\_\_

\_\_\_\_\_





## Collisions—Part 1

### Task

You will be observing colliding marbles, which demonstrate the law of conservation of momentum. The momentum of a moving object is the product of its mass and its velocity ( $M = mv$ ). If all of the marbles are identical in mass and size, a moving marble will transfer its momentum to a stationary marble when they collide.

### Parameter

Make sure your marbles are identical in size and mass.

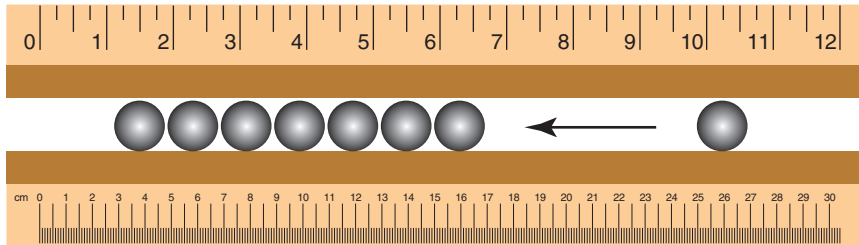

### Procedure

1. Place all eight marbles in the ruler groove next to and touching each other.
2. Pull one of the marbles about 10 centimeters away from the rest and then push it back toward the other marbles, giving it some speed. Note what happens when the marbles collide.
3. Place the marbles back at their original position and pull two marbles about 10 centimeters away from the rest. Push the two marbles together toward the other six marbles so that they collide. Note what happens after the collision.
4. Repeat step 3 with three marbles, then four marbles, and finally, five marbles.

### Conclusion

1. When one marble bumps against the other seven, why does just one marble move away? \_\_\_\_\_

2. Did the other six marbles move much after the first collision? Why? \_\_\_\_\_

3. How many marbles moved away when you pulled three marbles back and made them collide with the remaining five marbles? \_\_\_\_\_

4. If you were to use a twice as massive marble to collide with the seven other marbles of regular mass, would that cause just one marble to move away? Explain. \_\_\_\_\_

5. Would the end marble also move faster when one is hitting the row with a faster speed? \_\_\_\_\_

### Materials

- Plastic ruler with center groove (30 centimeters long) or similar items for tracking the marbles, such as ornate wooden molding
- Eight identical marbles

*Don't forget to return the marbles.*

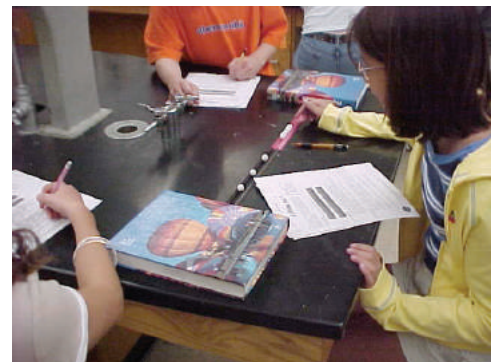

*The rulers must be properly set up to get the correct results for the collision activities.*



## Collisions—Part 2

### Materials

- Plastic ruler with center groove (30 centimeters long) or similar items for tracking the marbles, such as ornate wooden molding
- Two identical marbles
- Two identical books or boards to use as ramp supports

### Task

You will cause two moving marbles to collide and observe the direction of the movement after collision.

### Parameters

Make sure your marbles are identical in size and mass.

### Procedure

1. Make a ramp using each of the rulers and a support, such as a board or a book.
2. Place the ends of the rulers that are resting on the table facing each other separated by a 10-centimeter distance, as shown in figure 1.
3. Place a marble at the top of each ruler and then release the marbles at the same time. Note and record the direction of movement after the marbles collide. \_\_\_\_\_  
\_\_\_\_\_

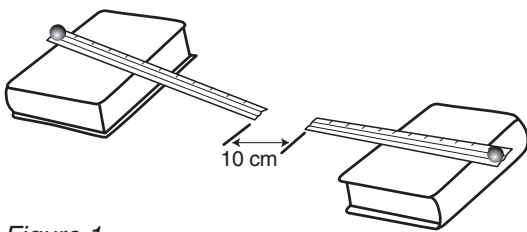

Figure 1.

4. Move the rulers farther apart so that there is 20 centimeters between them. Place a marble at the top of each ruler. Give one of the marbles a push, and let the other marble roll without a push (one fast-moving, one slow-moving). Note and record the differences between this collision and the collision in the previous step. \_\_\_\_\_  
\_\_\_\_\_  
\_\_\_\_\_

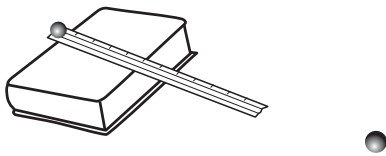

Figure 2.

5. Place one marble on the table 10 centimeters from the base end of one ruler to be a target. Place the other marble at the top of the ruler ramp, releasing it to hit the target marble. Note and record the direction of movement after the marbles collide (see fig. 2). \_\_\_\_\_  
\_\_\_\_\_  
\_\_\_\_\_

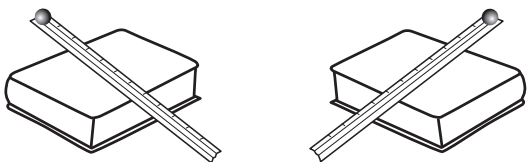

Figure 3.

6. Change the direction of the rulers so that they will collide and hit perpendicular to each other. Note and record the direction of movement after the marbles collide (see fig. 3). \_\_\_\_\_  
\_\_\_\_\_  
\_\_\_\_\_



7. Remove one of the rulers, placing the other ruler so that it faces the ramp stand directly head-on. Place a marble at the top of the ruler and release it. Note the direction that the marble moves after it collides with the ramp stand (see fig. 4). \_\_\_\_\_

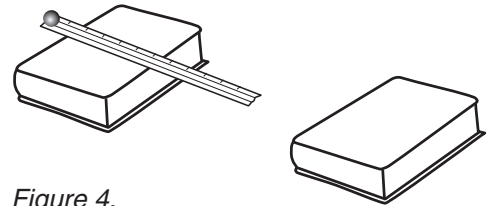

Figure 4.

8. Move the ruler so that it is at an angle with the ramp stand so that the marble will not hit head-on, such as in a side-impact collision (see fig. 5). Note the direction that the marble moves after it collides. \_\_\_\_\_

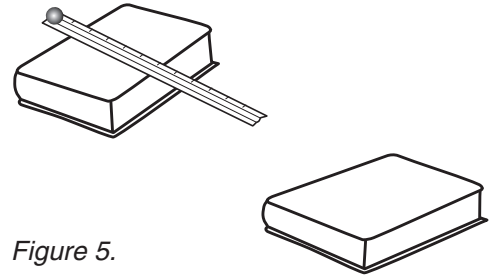

Figure 5.

9. Return the marbles to your teacher when you are finished with this activity.

### Conclusion

1. Describe or illustrate how the marbles moved after they collided head-on in step 3 of the procedure. Is kinetic energy (KE) conserved? \_\_\_\_\_
2. The marble that was pushed has more KE, because it is moving faster. After the collision, which marble has more KE? \_\_\_\_\_
3. Although the bumper car riders are strapped in and do not fly out of the car, their heads are relatively free to move. Two bumper cars have riders that are the same size and mass, but rider A's car is moving faster than rider B's car when the cars collide head-on.
  - a. What will be the resulting motion of each rider's head after collision (assuming they stay attached to the bodies)? \_\_\_\_\_
  - b. What will be the resulting motion of the cars after the collision? \_\_\_\_\_
4. If the marble sitting still at the bottom of the ramp in step 5 of the procedure were twice as massive as the marble rolling down the ramp, how would the resulting movement of marbles be different than what you observed? \_\_\_\_\_
5. Illustrate or describe the movement of the marbles after the collision that was set up in step 6 of the procedure. Is the KE of the marbles conserved after the collision? \_\_\_\_\_
6. How is the direction of movement following the collision in step 7 different from that in step 8 of the procedure? \_\_\_\_\_



## Marble Run—Part 1

### Materials

- Three half pieces of copper pipe insulation (gray, spongy); each piece 1.83 meters or 6 feet
- Masking tape
- One marble
- Stopwatch
- Meter stick

### Task

To work as a group to build a roller coaster and to diagram the forces of motion and energy transformations that apply to the track.

### Parameters

1. Use 5.49 meters (18 feet) of copper pipe insulation for the track.
2. Select any type of marble, but only one marble. You will be able to make one switch if you want to change marble type.
3. Avoid putting tape on the surface of the track on which the marble rides.
4. This is not a race, so take time to enjoy it.

### Procedure

1. As a group, build a roller coaster that has
  - An initial hill and one additional hill
  - A complete loop
  - A gap where two pieces of track do not touch each other
  - A run that a marble can roll the entire distance of the track (except at the gap)
2. Time five complete marble runs.
3. Sketch the shape of the coaster below.
4. Label the forces that are present during the marble run (include gravitational, centripetal, and frictional).
5. Label energy transformations in your diagram where the potential energy and kinetic energy increases or decreases.

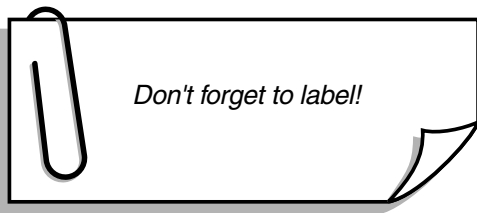

### Roller Coaster Diagram

Average time for 5 trials \_\_\_\_\_



## Marble Run—Part 2

### Task

To work as a group to calculate the average speed of a marble for the team’s roller coaster, and to draw the roller coaster to scale.

### Parameters

1. Use 5.49 meters (18 feet) of copper pipe insulation for the track.
2. Select any type of marble, but only one marble. You will be able to make 1 switch if you want to change marble type.
3. Avoid putting tape on the surface of the track on which the marble rides.

### Procedure

1. As a group, build a roller coaster that has
  - An initial hill and one additional hill
  - A complete loop
  - No gap
  - A run that a marble can roll the entire distance of the track
2. Draw a scale drawing of your roller coaster using the grid graph below.
3. Time the marble from start to finish five times and calculate the average time of travel.
4. Calculate the average speed of the marble.  
( $s = d/t$ , where  $s$  = speed,  $d$  = distance, and  $t$  = time)

**Materials**

- Three half pieces of copper pipe insulation (gray, spongy); each piece 1.83 meters or 6 feet
- Masking tape
- One marble
- Stopwatch
- Meter stick
- Digital camera (optional)



*Make sure you leave enough time to make the scale drawing and time five marble runs.*

### Scale drawing of roller coaster: 1 block = 20 centimeters

(Suggestion: Photograph your roller coaster with two meter sticks at right angles to represent the X and Y axes.)

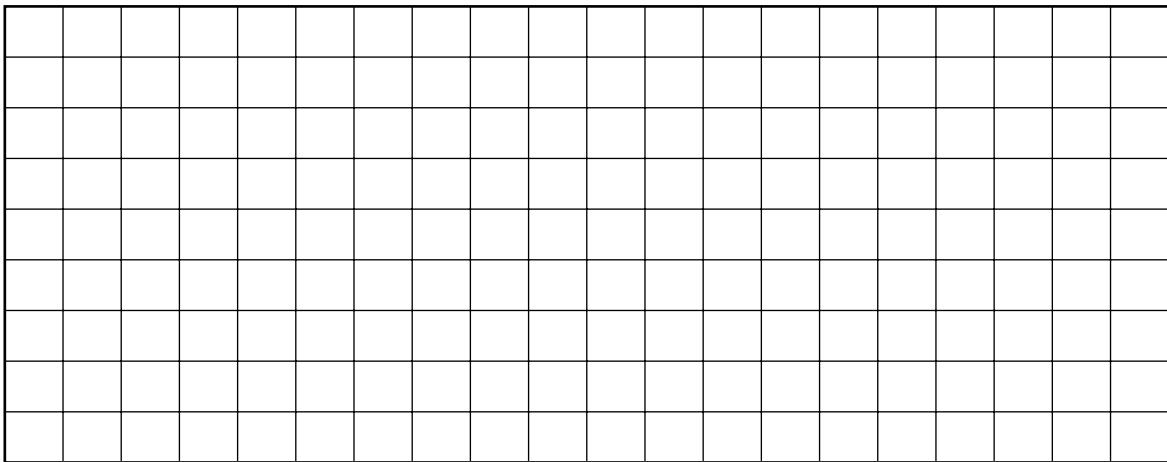

## Data and Calculations

Trial	Distance, m	Time, s	Speed, m/s
1	5.45		
2	5.45		
3	5.45		
4	5.45		
5	5.45		
Average	5.45		



*Arranging the hill parameters for the marble run activities takes teamwork.*



*Students build a marble run roller coaster using copper pipe insulation. How is this for a total team effort?*



## Marble Run—Part 3

### Task

To build a roller coaster with a 4-foot hill where the marble stays on the track at all times and to calculate the average speed of the marble for five trials.

### Parameters

1. The first hill must be at a height of 1.22 meters (4 feet) measured from the top of the first hill to the bottom of the first hill.
2. The two additional hills should be as tall as possible.
3. The marble must run the entire length of two pieces of track, 3.66 meters (12 feet).
4. You may add turns or any side motion to the track to increase speed.
5. You may try different types of marbles (small, big, heavy, and light).

### Procedure

1. As a group, build a roller coaster that has
  - Three hills
  - Conditions to allow the marble to remain on the track for the entire run (the marble cannot leave the track at any point)
2. Use a stopwatch to time the marble from the beginning to the end of the track. Repeat for a total of five trials. Record the times below.
3. Calculate the average speed of the marble (speed = distance divided by time). Record below.
4. Draw your roller coaster on the following page and indicate the height of each hill.

### Materials

- Two half pieces of copper pipe insulation (gray, spongy); each piece 1.83 meters or 6 feet
- Masking tape
- One marble
- Stopwatch
- Meter stick

*Don't forget to return the marbles!*

## Data and Calculations

Trial	Distance, m	Time, s	Speed, m/s
1	3.67		
2	3.67		
3	3.67		
4	3.67		
5	3.67		
Average	3.67		



Draw your coaster and label the height of each hill in centimeters. Label the four items listed in the conclusion below.



### Conclusion

1. To compare your coaster's potential energy (PE) use with others in the class, what was the combined height of the three hills of your coaster? \_\_\_\_\_
2. Indicate on your diagram the one location where the PE of the coaster is the greatest (maximum PE). Note, there can only be one of these for the entire coaster.
3. Indicate on your diagram, the area of each hill where PE is decreasing and kinetic energy (KE) is increasing. (PE↓ KE↑)
4. Indicate on your diagram where the KE of the coaster is the highest (maximum KE). Note, there can only be one of these for the entire coaster. When you are finished with your drawing it should have each of the following things labeled:
  - Height of each hill
  - Maximum PE (one only)
  - Areas of PE↓ KE↑
  - Maximum KE (one only)





## Marble Run—Part 4

One of the most exciting parts of a roller coaster ride is feeling weightless while traveling over a hill. If the coaster can simulate the path of a projectile (like a ball that rolls off a table) the riders will come close to experiencing free fall and will feel weightless.

### Task

As a group, test three different hill formations to find out the optimal hill shape for a roller coaster.

**Materials**

- Two half pieces of copper pipe insulation (gray, spongy); each piece 1.83 meters or 6 feet
- Masking tape
- One marble
- Stopwatch
- Meter stick

### Parameters

1. Use two pieces of track. The marble must run the entire length of track.
2. The marble cannot leave the track at any time from start to finish.
3. You may try different types of marbles (small, big, heavy, and light), but you must use the same one for all three hills.



*The starting heights will directly affect the speed of the marbles. Each hill shape is optimal for one starting level.*

### Procedure

1. Tape the two tracks together on the bottom.
2. Test three different types of hills (A, B, and C) from three different starting heights (levels 1, 2, and 3). Determine which hill shape is optimal for each starting height. Level 1 is 1.0 meters, level 2 is 0.8 meters, and level 3 is 0.6 meters above the lowest point of the hill (see diagrams below). Note, the heights of the middle hill shown in the diagrams are exaggerated for purposes of clarity.

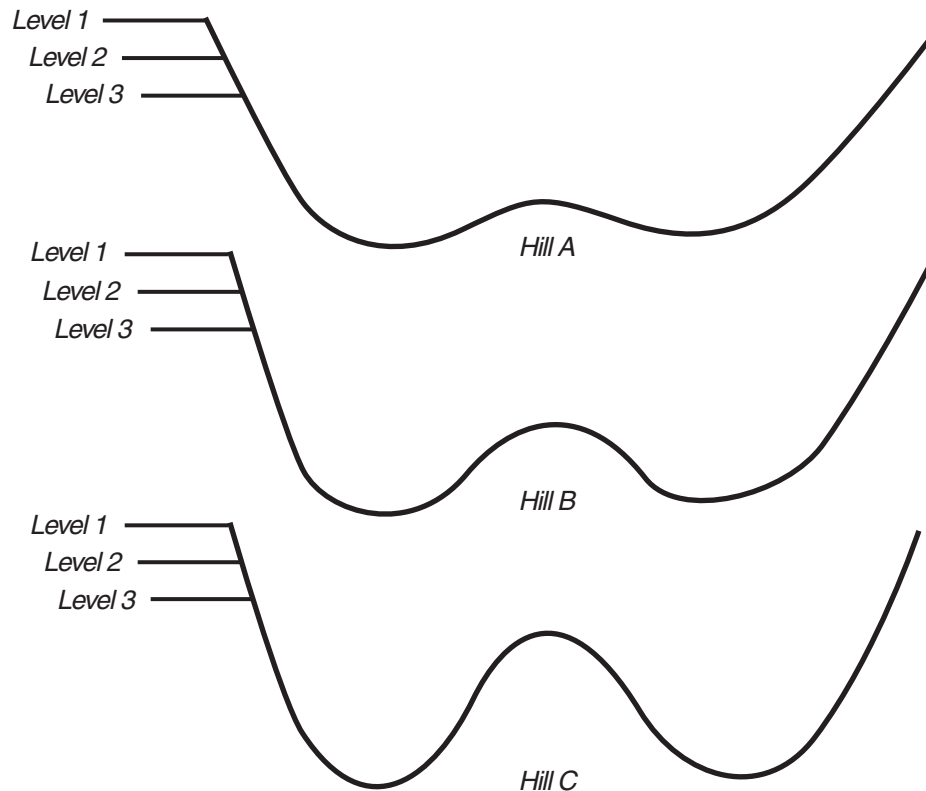

Fill in the table below according to the following descriptions:

**Optimal hill**—The marble is close to free fall for the longest period of time, and is softly caught at the bottom. This is the fastest ride while still staying on the track.

**Safe hill**—The marble stays on the track, but is not traveling as fast as it could, nor does it remain close to free fall for the maximum amount of time.

**Unsafe hill**—The marble leaves the track and possibly hits the other side of the track, or the marble doesn't have enough speed to go over a hill or complete a loop.

Starting height	Hill A	Hill B	Hill C
1			
2			
3			

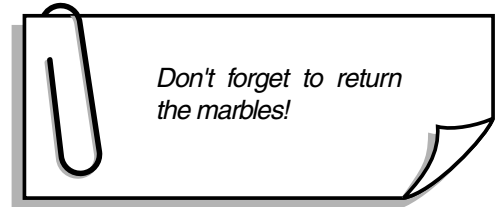

**Conclusion**

1. Which hill type is optimal when starting the marble at level 1, and why do you think this is true?

---

---

---

2. Which hill type is optimal when starting the marble at level 2, and why do you think this is true?

---

---

---

3. Which hill type is optimal when starting the marble at level 3, and why do you think this is true?

---

---

---

4. When you ride down a roller coaster hill, does the angle of the slope of the track make a difference in the sensation that you get on the ride? Why? \_\_\_\_\_

---

---

---



# NASA Connection—Student Reading Guide





# NASA Connection—Student Reading Guide

Read the following NASA Connection section, then use a separate piece of paper to answer the following questions.

## Free-Fall Rides

1. When do the effects of gravity seem to disappear on free-fall rides?
2. How is an orbiting shuttle similar to a free-fall ride?
3. What facilities do scientists who study the effects of microgravity use at Glenn Research Center?
4. Which drop tower located at the Glenn Research Center has the least amount of air resistance when the experiment drops?

## Roller Coasters

1. What does it feel like when you are experiencing high  $g$  on a roller coaster ride?
2. How long does it take the Space Shuttle orbiter to travel from the ground to orbit?
3. What is the KC-135?
4. How is the KC-135's flight path similar to a roller coaster?

## Bumper Cars

1. You collide head-on with another car. Describe how Newton's third law of motion applies.
2. How does Newton's second law of motion apply to a rocket launch?
3. How much microgravity experiment time does a sounding rocket provide?

## Carousel

1. What would happen to the riders if the carousel spun out of control?
2. What type of acceleration is acting on the riders once the ride has achieved a constant speed?
3. The banking of curves on a road is similar to what on a carousel?
4. How did the first fundamental space biology experiment on the ISS simulate  $1\ g$ ?

## Loop Coasters

1. What sensation (high  $g$ , low  $g$ , or normal  $g$ ) do you experience most when riding the inside loop of a roller coaster?
2. How is the force you experience in a loop different than the sensation you have going over the top of a floater hill?
3. When does a KC-135 fly in banked curves for extended periods of time?

## Pendulum Rides

1. When is high  $g$  experienced on the KC-135?
2. When is high  $g$  experienced on a pendulum ride (as the rider reaches the bottom of the arc or as the rider reaches the top of the arc)?
3. When is low  $g$  experienced on the pendulum ride?
4. What is the difference between the flight path of the KC-135 and the circular motion of the pendulum ride?



# NASA Connection—Student Reading Guide Answer Key

## Free-Fall Rides

1. When do the effects of gravity seem to disappear on free-fall rides?

*The effects of gravity seem to disappear during the actual fall, when the car and rider are falling at the same rate.*

2. How is an orbiting shuttle similar to a free-fall ride? *The orbiting shuttle is falling toward Earth.*
3. What facilities do scientists who study the effects of microgravity use at Glenn Research Center?  
*Scientists use the 2.2-second and 5.2-second drop towers to study microgravity at the Glenn Research Center.*
4. Which drop tower located at the Glenn Research Center has the least amount of air resistance when the experiment drops?

*The 5.2-second drop tower has the least amount of air resistance because the air is evacuated from the drop tower before each drop.*

## Roller Coasters

1. What does it feel like when you are experiencing high g on a roller coaster ride?

*You get pushed back or pushed down in your seat, you feel like something heavy is on your chest, and at times your face feels like something is pushing in on it.*

2. How long does it take the Space Shuttle orbiter to travel from the ground to orbit?

*It takes the Shuttle orbiter 8 minutes to travel from the ground to orbit altitude.*

3. What is the KC-135?

*The KC-135 is a NASA research aircraft.*

4. How is the KC-135's flight path similar to a roller coaster?

*The KC-135 flies parabolas similar to continuous roller coaster hills.*

## Bumper Cars

1. You collide head-on with another car. Describe how Newton's third law of motion applies.

*Both cars bounce backward because equal and opposite forces are acting on the cars.*

2. How does Newton's second law of motion apply to a rocket launch?

*The amount of fuel and engine size needed for thrust depends on the weight of the rocket and its payload. The greater the mass, the greater the amount of force needed to accelerate it.*

3. How much microgravity experiment time does a sounding rocket provide?

*Sounding rockets provide 6 to 8 minutes of microgravity.*

## Carousel

1. What would happen to the riders if the carousel spun out of control?

*Riders would fly off of the carousel.*

2. What type of acceleration is acting on the riders once the ride has achieved a constant speed?

*Centripetal acceleration occurs in a turn.*

3. The banking of curves on a road is similar to what on a carousel?

*Banking of road curves is similar to leaning poles and benches on the carousel.*

4. How did the first fundamental space biology experiment on the ISS simulate 1 g?

*The experiment used a carousel to spin quail eggs to simulate 1 g in their development.*



## Loop Coasters

1. What sensation (high  $g$ , low  $g$ , or normal  $g$ ) do you experience most when riding the inside loop of a roller coaster?  
*Most of the time the rider experiences high  $g$  in a loop. Depending on the geometry of the track and many other ride conditions, one may experience a range from low to normal to high  $g$  at the top of the loop.*
2. How is the force you experience in a loop different than the sensation you have going over the top of a floater hill?  
*You feel pushed into your seat in the loop and you feel like you are flying out of your seat when going over the top of a floater hill.*
3. When does a KC-135 fly in banked curves for extended periods of time?  
*The KC-135 flies in banked curves for extended periods of time if researchers want to study the effects of high  $g$  on experiments.*

## Pendulum Rides

1. When is high  $g$  experienced on the KC-135?  
*High  $g$  is felt when the KC-135 pulls up and out of the parabola.*
2. When is high  $g$  experienced on a pendulum ride (as the rider reaches the bottom of the arc or as the rider reaches the top of the arc)?  
*High  $g$  is felt on the pendulum ride as the rider reaches the bottom of the arc.*
3. When is low  $g$  experienced on the pendulum ride?  
*Low  $g$  is experienced when the riders reach the top of the arc.*
4. What is the difference between the flight path of the KC-135 and the circular motion of the pendulum ride?  
*The flight path of the KC-135 is a parabola path and the pendulum ride is a circular path.*



## NASA Connection—Free-Fall Rides



*Demon Drop—a free-fall ride.*

A free-fall ride, like the one pictured here, lets you fall for about 1.5 seconds. Once the car is lifted to the top and released, the force of gravity pulls it toward the ground. You are inside falling at the same rate as the car; the effects of gravity seem to disappear. This is similar to what astronauts experience on the space shuttle or ISS. The space vehicles are falling toward the Earth just as you were falling towards the ground. The astronauts inside are falling at the same rate as the vehicle. Thus, the astronauts float. On rides, however, the riders experience the weightless feeling for less than 2 seconds, while the astronauts experience it for days or months.

Two facilities at NASA Glenn Research Center are very similar to a free-fall ride. Scientists that study the effects of microgravity on fluids, combustion, and materials use either the 2.2-second drop tower or the 5.2-second drop tower. An experiment is prepared in a special configuration, suspended above an airbag or pit of Styrofoam™ beads and then dropped. The 2.2-second drop tower uses an airbag to stop the experiment, which is traveling 22 meters/seconds (50 mph) before impact. The 5.2-second drop tower experiments travel 50 meters/seconds (110 mph) near the bottom. A pit holding small Styrofoam™ beads (similar to those inside of a beanbag chair) decelerates the experiment. The 5.2-second drop tower has little air resistance because all of the air is pumped out of the chamber before the experiment is dropped.

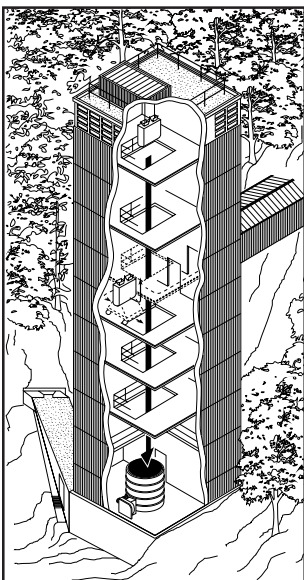

*The 2.2-second drop tower.*

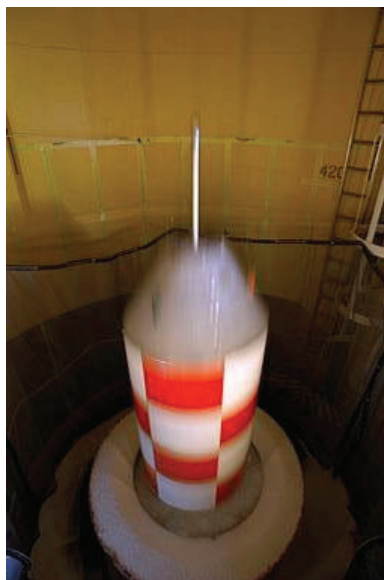

*An experiment at the end of its fall inside the 5.2-second drop tower.*



*International Space Station.*





## NASA Connection—Roller Coasters

Once roller coaster cars start moving, your body is forced to change direction with the cars because of the track and your seatbelt. As the coaster car reaches the top of a hill, the rider's body tends to keep moving upward in a straight line due to inertia. The car curves away as it follows the track. As a result, the rider is lifted out of the seat until the rider experiences low  $g$ . At the bottom of a hill the rider is pushed into the seat and he or she experiences a force greater than that of gravity, making one feel heavy. The riders are experiencing high  $g$  at that point.

Astronauts experience extreme shifts in  $g$  when they are launched into orbit by the shuttle transportation system. They are at 1  $g$  on the ground and within 2 minutes they are experiencing about 3  $g$  which then lasts for about 6 minutes. Once they are in orbit (after about 8 minutes total) they are in free fall and experience 0  $g$ . Their bodies adjust to the new "weightless" environment after about 1 day.

The KC-135 is a NASA research aircraft that flies parabolas similar to continuous roller coaster hills. As the pilot controls the plane's direction, the passengers bodies want to continue on a parabolic path, just like on a coaster. Unlike a coaster, they are not harnessed down and there is no track, so they float until the plane pulls out of the arc (about 20 seconds). As the plane pulls out of the parabolic path, the researchers again hit the floor and experience up to 2  $g$ .



*A scientist doing microgravity research on the KC-135 experiences microgravity conditions.*

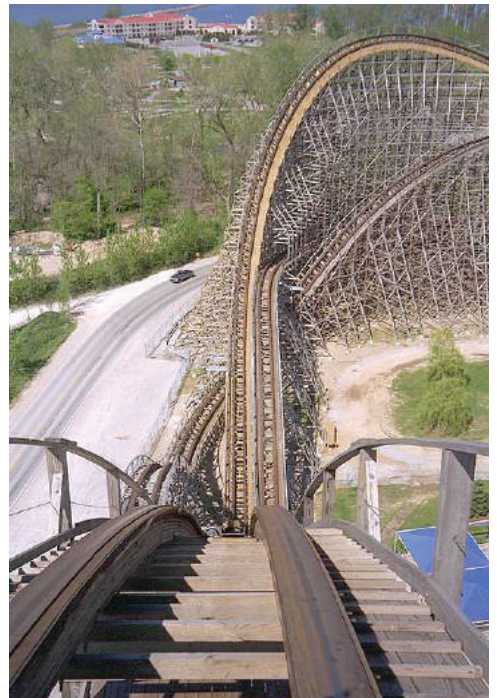

*Mean Streak—When the roller coaster rolls over the top of a hill, seat restraints keep the rider's body from moving upward.*



*Astronauts experience a maximum of 3  $g$  during liftoff, similar to the high  $g$  felt on a roller coaster.*



## NASA Connection—Bumper Cars



Three bumper cars colliding are an excellent example of Newton's laws of motion.

When bumper cars are not spinning in circles, they travel along linear paths. They also provide firsthand experience with Newton's laws of motion.

How do Newton's laws of motion apply to bumper cars?

- First law of motion: Before the driver has pressed on the "gas" pedal, the car is at rest. The driver, after pushing on the pedal, begins traveling in a straight line at a steady speed. Unless the driver hits another car, steps on the brakes, turns the steering wheel, or accelerates the car (so that there is no net external force acting), the motion of the car will remain in a straight line. So unless a net external force acts on an object, it will remain at rest if at rest or move in a straight line at a constant speed if in motion.
- Second law of motion: The driver and the car are both moving at a constant rate across the floor when another car that is moving faster than the first driver hits the car. The car that is hit will either speed up or slow down, depending on the direction of the hit, due to the force of impact. The harder the car is hit, the greater the change of speed or acceleration.
- Third law of motion: What happens if two drivers collide head-on with each other? Both cars will bounce backward after collision. Each car exerts an equal and opposite force on the other car causing them both to accelerate and move in the opposite direction. For every action or force, there is an equal and opposite reaction force.



Thrust causes a Black Brant XII sounding rocket to take off.

Rockets are a very good example of Newton's laws of motion in action. The rocket starts out on a launch pad, where it is not moving. The amount of thrust required for the rocket to move upward depends on the mass of the rocket and the mass of the payload (the experiment) that it is carrying. As the rocket engines fire, the exhaust thrusts down while the rocket gets propelled upward.

Sounding rockets are another microgravity research tool used by scientists. The rockets provide scientists with 6 to 8 minutes of microgravity by coasting after the rocket engines are turned off. Scientists who have an experiment that needs more microgravity flight time than a KC-135 to obtain appropriate data will sometimes use a sounding rocket.



## NASA Connection—Carousels

Carousels are by no means a thrill ride, yet they rely on Newton's laws of motion as much as roller coasters. It is actually possible that if allowed to spin out of control, a carousel could gain enough speed so that the riders would be thrown off. Fortunately, runaway carousels do not exist. The carousel is a delicate balance of motion and forces. All of the horses move through one complete circle in the same amount of time. This means the inside horses have a slower linear speed than the outside horses because they do not have to move as far.

Centripetal acceleration occurs whenever the rider makes a turn. Both centripetal force and the resulting acceleration are directed inward, toward the center of the circle. There has to be an inward force if one is to move in a circular path, otherwise one continues on a straight path. The riders, however, experience a sensation of an outward force. This is the same experience as rounding a tight curve in an automobile. The passengers feel pushed against their door, when actually inertia is causing them to move in a straight line that is tangent to the circular path of motion.



*A carousel ride is a ride that has centripetal acceleration.*

Curves are banked on roads to prevent the necessity of a large friction force from the tires on the road. The banking of curves transfers this sideways force to a downward direction, thus reducing the needed friction. The leaning of the benches and poles on the carousel is the same as the banking of a curve. The direction of the outward force is changed to another direction.

The first fundamental space biology experiments to fly on the International Space Station used a carousel to simulate gravity conditions for bird eggs (Japanese quail). The experimental setup was in an apparatus called the Avian Development Facility (ADF). The ADF has special egg holders that fit into two centrifuge carousels, which can be independently programmed to simulate different gravity levels; from 0 up to 1 g. The purpose of the ADF experiment was to observe developmental changes of quail embryos in near weightless conditions.



*Japanese quail eggs are tested in micro-gravity conditions.*





*The Raptor is located at Cedar Point in Sandusky, Ohio.*



*The Mantis provides thrills to riders at Cedar Point in Sandusky, Ohio.*

## NASA Connection—Roller Coasters—Loops

Loop roller coasters may seem scary to riders. They may think that they could fall out as the car goes around the loop. However, in reality, when the rider travels in a loop fast enough, it creates a sensation that there is a force pushing him or her into the seat, especially entering and exiting the loop. The sensation that the riders have is one of high  $g$ . The force they experience comes from the track (or whatever holds the car into the loop). The track pushes in on the car and riders, while the car and their bodies continue to travel in a straight line. This creates the increased force acting on the car and the riders. This is very different than approaching and going over the top of a hill on a traditional roller coaster, where the rider experiences weightlessness. No wonder many people have a headache by the end of the day!

If riders feel weighted down in their seats in a loop-de-loop, imagine flying in a high-speed aircraft. A coaster car in a loop will probably not exceed 3  $g$ , similarly the KC-135 pulls 2 to 3  $g$  as it heads back upward after a  $45^\circ$  descent when flying parabolas. Sometimes the KC-135 flies in banked curves for extended periods of time so researchers can study the effects of high  $g$  on experiments. Military aircraft can pull up to 10  $g$ , but the pilots must wear special pressure suits to keep them from blacking out.



*A KC-135 jet aircraft.*



## NASA Connection—Pendulum Rides

Although most pendulum riders do not make a full circle, riders do experience circular motion. Swinging back and forth on this curved path allows you to feel the sensations of high and low  $g$  (“ $g$ ” refers to the force caused by the acceleration of gravity).

On the pendulum ride, the riders feel both high and low accelerations like the researchers do on the KC-135 aircraft. The KC-135 follows a parabolic path that plummets about 2400 meters (approximately 8000 feet) before nosing up. As the airplane pulls up and out of the parabola, high  $g$  is felt. Just before, during, and just after it flies over the top of the parabola, the passengers inside feel weightless. Unlike a pendulum ride in which the car swings passengers back and forth along the same arc, the KC-135 flies a series of continuous curves.

The KC-135 flight path looks similar to the path of a pendulum ride. However, the path of the pendulum is a circle, while the path of the KC-135 is a parabola.



*A pendulum-type ride at an amusement park.*

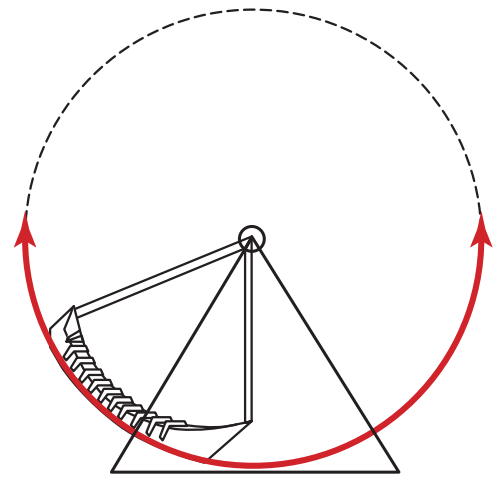

*A drawing of a typical pendulum-type ride.*

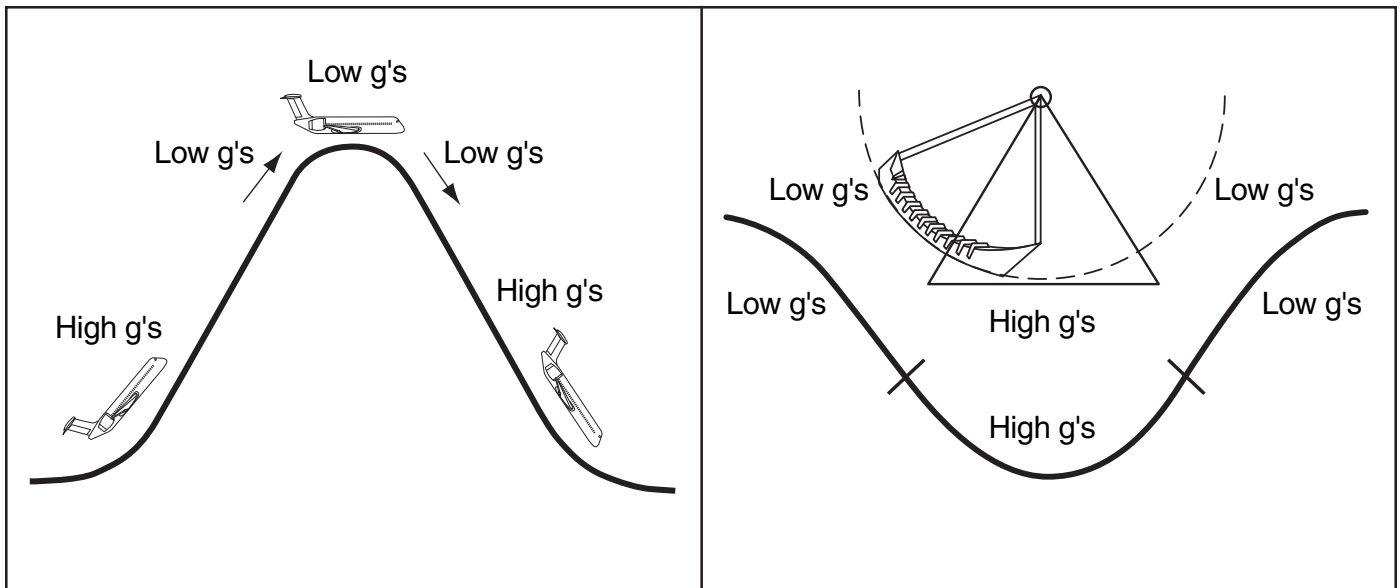

*The flight path of the KC-135 aircraft.*

*KC-135 flight path with an overlay of the path of a pendulum-type ride.*





# Ride Work Book



*The Tower of Doom is located at Six Flags of America, Largo, Maryland. The riders plunge into free fall from a height of 150 feet. This ride has magnetic brakes to cushion the descent.*



*Millennium Force's initial hill has a steepness angle of  $80^\circ$ . At that angle, the riders swear that they are in free fall. Millennium Force is located at Cedar Point, Sandusky, Ohio.*



*On the Roll-O-Plane ride, the cars roll around as the arm rotates. It is located in Kennywood Park, West Mifflin, Pennsylvania.*

**School** \_\_\_\_\_ **Group number** \_\_\_\_\_

**Names** \_\_\_\_\_

\_\_\_\_\_  
\_\_\_\_\_  
\_\_\_\_\_  
\_\_\_\_\_







# Free-Fall Rides

## Ground Measurements

Stand near the ride entrance to take the following measurements:

- Using figure 1, estimate how high the ride car actually goes (point A) using the scale drawing method of angles and point of intersection. If you forgot how to do this, see the Basic Skills section. Show your work below.

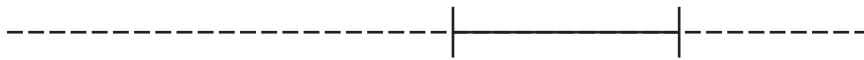

- Estimate the height of point B. Calculate the distance between point A and point B. Show your work in the space below.

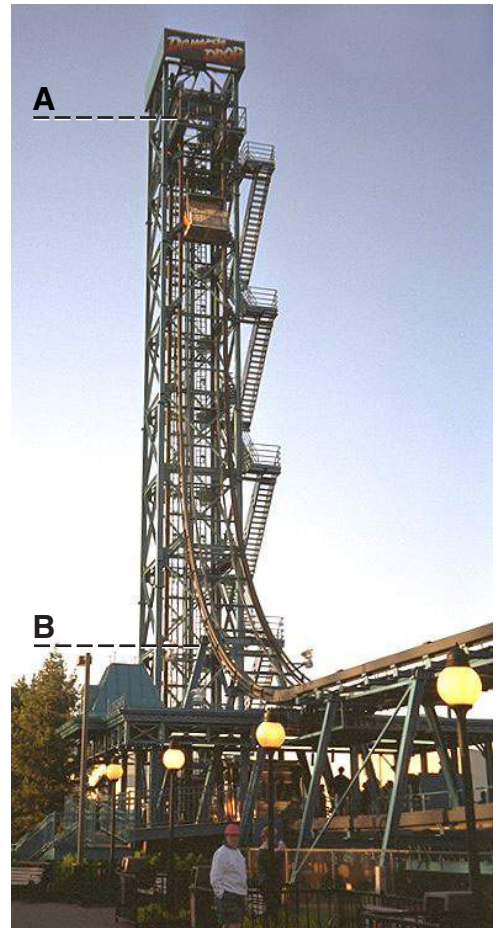

Figure 1.

- Calculate the average speed of the ride.
  - Time the lift from the start point to the highest point (point A in fig. 1) the car travels. Time three different cars as they travel from the start to point A. Fill in the table below.
  - Time the fall from point A to point B. Stop the timer as soon as the car reaches the low point of the ride (point B in fig.1). Don't wait for the ride to come to a complete stop. Time three different cars as they travel from point A to point B. Fill in the table below.

	Time trial 1	Time trial 2	Time trial 3	Average time	Distance using figure 1 above	Average speed, $s=d/t$
Lift to A						
Fall from A to B						



## Free-Fall Rides Ride Measurements

When measuring the end of the fall, make sure that you measure the g's before the ride bends away from the vertical.

1. Take the accelerometer on the ride to measure the accelerations (g's) during the ride.
2. Complete column g in the data table below.
3. Indicate with an "X" which of the four locations below have a maximum KE, maximum PE, minimum KE, or minimum PE. There should be only one "X" in each column. That is, there is only one location (either during the lift, at the top of the ride, during the fall, or the end of the fall) in which there is a maximum KE. Remember, KE is energy of motion and PE is energy of position.

	g	Maximum KE	Maximum PE	Minimum KE	Minimum PE
During the lift					
At the top of the ride					
During the fall					
End of the fall					



*A team of girls is working together to answer the ride worksheet questions.*



# Roller Coasters—Initial Hill

## Ground Measurements

Find a coaster that has an initial hill that can be measured using the structure estimation method.

1. Estimate the height of the first hill from the ground by using the design of the structures. See the Basic Skills section if you have forgotten how to do it. Show your work below.

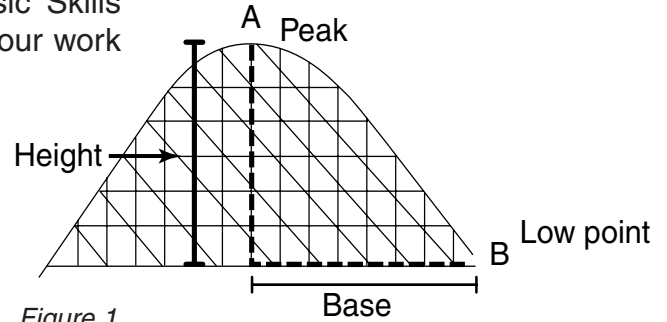

Figure 1.

2. Find the base length of the hill going down, from point A to point B, by stepping (see fig. 1).
3. Calculate the approximate hill distance by using the Pythagorean theorem. (Note, this is an approximation of the distance up the first hill because the track is curved at the top and bottom.) Show your work.  

$$(\text{base}^2 + \text{height}^2 = \text{hill distance}^2)$$

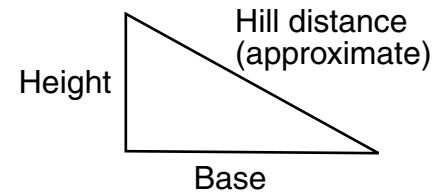

Figure 2.

4. Time the roller coaster going down the first hill from point A to point B as shown in figure 1. Do this three times and fill in the data table below.
5. Calculate the average speed of the cars down the first hill. First find the average time of your three trials, and then calculate ( $s = d/t$ ). Fill in data table below.

	Time trial 1	Time trial 2	Time trial 3	Average time	Distance, m	Speed, m/s
From A to B						



## Roller Coasters—Initial Hill Ride Measurements

Take the accelerometer on the ride, paying close attention to the g measurements.

1. When do microgravity ( $<1$  g) moments occur (up and over a hill, down a hill and into a valley, up a hill, down a hill, over the crest of a hill, going through a valley, around curves)?  
\_\_\_\_\_  
\_\_\_\_\_

2. What was the highest g-level reading you observed? Where was it (up and over a hill, down a hill and into a valley, up a hill, down a hill, over the crest of a hill, going through a valley, around curves)? \_\_\_\_\_  
\_\_\_\_\_  
\_\_\_\_\_



*A student is using the altitude tracker to measure the height of a ride.*



# Bumper Cars Ride Measurements

For each collision shown below, circle the appropriate set of arrows to indicate which direction the cars and riders move immediately after impact. Assume the masses of riders A and B are equal.

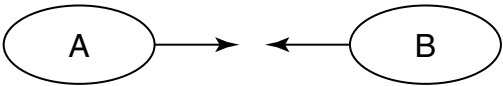
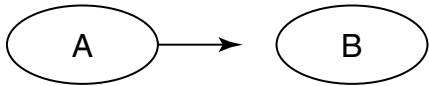
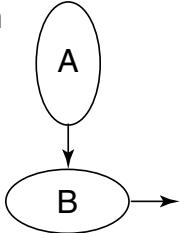
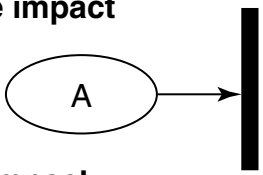
<p><b>1. Head-on collision</b></p> <p><b>Before impact</b></p>  <p><b>After impact</b></p> <table style="width: 100%; border: none;"> <tr> <td style="width: 15%;">Cars:</td> <td style="width: 15%;">A</td> <td style="width: 15%;">B</td> <td style="width: 15%;"></td> <td style="width: 15%;">B</td> </tr> <tr> <td>a.</td> <td>→</td> <td>→</td> <td></td> <td></td> </tr> <tr> <td>b.</td> <td>←</td> <td>no motion</td> <td></td> <td></td> </tr> <tr> <td>c.</td> <td>←</td> <td>→</td> <td></td> <td></td> </tr> <tr> <td>d.</td> <td>no motion</td> <td>←</td> <td></td> <td></td> </tr> </table> <table style="width: 100%; border: none;"> <tr> <td style="width: 15%;">Riders:</td> <td style="width: 15%;">A</td> <td style="width: 15%;">B</td> <td style="width: 15%;"></td> <td style="width: 15%;">B</td> </tr> <tr> <td>a.</td> <td>→</td> <td>←</td> <td></td> <td></td> </tr> <tr> <td>b.</td> <td>←</td> <td>no motion</td> <td></td> <td></td> </tr> <tr> <td>c.</td> <td>←</td> <td>→</td> <td></td> <td></td> </tr> <tr> <td>d.</td> <td>no motion</td> <td>←</td> <td></td> <td></td> </tr> </table>	Cars:	A	B		B	a.	→	→			b.	←	no motion			c.	←	→			d.	no motion	←			Riders:	A	B		B	a.	→	←			b.	←	no motion			c.	←	→			d.	no motion	←			<p><b>2. Rear-end collision</b></p> <p><b>Before impact</b></p>  <p><b>After impact</b></p> <table style="width: 100%; border: none;"> <tr> <td style="width: 15%;">Cars:</td> <td style="width: 15%;">A</td> <td style="width: 15%;">B</td> <td style="width: 15%;"></td> <td style="width: 15%;">B</td> </tr> <tr> <td>a.</td> <td>←</td> <td>no motion</td> <td></td> <td></td> </tr> <tr> <td>b.</td> <td>no motion</td> <td>→</td> <td></td> <td></td> </tr> <tr> <td>c.</td> <td>→</td> <td>→</td> <td></td> <td></td> </tr> <tr> <td>d.</td> <td>no motion</td> <td>←</td> <td></td> <td></td> </tr> </table> <table style="width: 100%; border: none;"> <tr> <td style="width: 15%;">Riders:</td> <td style="width: 15%;">A</td> <td style="width: 15%;">B</td> <td style="width: 15%;"></td> <td style="width: 15%;">B</td> </tr> <tr> <td>a.</td> <td>→</td> <td>←</td> <td></td> <td></td> </tr> <tr> <td>b.</td> <td>→</td> <td>no motion</td> <td></td> <td></td> </tr> <tr> <td>c.</td> <td>←</td> <td>→</td> <td></td> <td></td> </tr> <tr> <td>d.</td> <td>no motion</td> <td>←</td> <td></td> <td></td> </tr> </table>	Cars:	A	B		B	a.	←	no motion			b.	no motion	→			c.	→	→			d.	no motion	←			Riders:	A	B		B	a.	→	←			b.	→	no motion			c.	←	→			d.	no motion	←		
Cars:	A	B		B																																																																																																	
a.	→	→																																																																																																			
b.	←	no motion																																																																																																			
c.	←	→																																																																																																			
d.	no motion	←																																																																																																			
Riders:	A	B		B																																																																																																	
a.	→	←																																																																																																			
b.	←	no motion																																																																																																			
c.	←	→																																																																																																			
d.	no motion	←																																																																																																			
Cars:	A	B		B																																																																																																	
a.	←	no motion																																																																																																			
b.	no motion	→																																																																																																			
c.	→	→																																																																																																			
d.	no motion	←																																																																																																			
Riders:	A	B		B																																																																																																	
a.	→	←																																																																																																			
b.	→	no motion																																																																																																			
c.	←	→																																																																																																			
d.	no motion	←																																																																																																			
<p><b>3. Side-impact collision</b></p> <p><b>Before impact</b></p>  <p><b>After impact</b></p> <table style="width: 100%; border: none;"> <tr> <td style="width: 15%;">Cars:</td> <td style="width: 15%;">A</td> <td style="width: 15%;">B</td> <td style="width: 15%;"></td> <td style="width: 15%;">B</td> </tr> <tr> <td>a.</td> <td>↓</td> <td>→</td> <td></td> <td></td> </tr> <tr> <td>b.</td> <td>↘</td> <td>↘</td> <td></td> <td></td> </tr> <tr> <td>c.</td> <td>↙</td> <td>↘</td> <td></td> <td></td> </tr> <tr> <td>d.</td> <td>no motion</td> <td>↘</td> <td></td> <td></td> </tr> </table> <table style="width: 100%; border: none;"> <tr> <td style="width: 15%;">Riders:</td> <td style="width: 15%;">A</td> <td style="width: 15%;">B</td> <td style="width: 15%;"></td> <td style="width: 15%;">B</td> </tr> <tr> <td>a.</td> <td>↓</td> <td>→</td> <td></td> <td></td> </tr> <tr> <td>b.</td> <td>↘</td> <td>↘</td> <td></td> <td></td> </tr> <tr> <td>c.</td> <td>↙</td> <td>↘</td> <td></td> <td></td> </tr> <tr> <td>d.</td> <td>↓</td> <td>↓</td> <td></td> <td></td> </tr> </table>	Cars:	A	B		B	a.	↓	→			b.	↘	↘			c.	↙	↘			d.	no motion	↘			Riders:	A	B		B	a.	↓	→			b.	↘	↘			c.	↙	↘			d.	↓	↓			<p><b>4. Car hits wall</b></p> <p><b>Before impact</b></p>  <p><b>After impact</b></p> <table style="width: 100%; border: none;"> <tr> <td style="width: 15%;">Car:</td> <td style="width: 15%;">A</td> <td style="width: 15%;"></td> <td style="width: 15%;"></td> <td style="width: 15%;">B</td> </tr> <tr> <td>a.</td> <td>→</td> <td></td> <td></td> <td></td> </tr> <tr> <td>b.</td> <td>←</td> <td></td> <td></td> <td></td> </tr> <tr> <td>c.</td> <td>no motion</td> <td></td> <td></td> <td></td> </tr> </table> <table style="width: 100%; border: none;"> <tr> <td style="width: 15%;">Rider:</td> <td style="width: 15%;">A</td> <td style="width: 15%;"></td> <td style="width: 15%;"></td> <td style="width: 15%;">B</td> </tr> <tr> <td>a.</td> <td>→</td> <td></td> <td></td> <td></td> </tr> <tr> <td>b.</td> <td>←</td> <td></td> <td></td> <td></td> </tr> <tr> <td>c.</td> <td>no motion</td> <td></td> <td></td> <td></td> </tr> </table>	Car:	A			B	a.	→				b.	←				c.	no motion				Rider:	A			B	a.	→				b.	←				c.	no motion													
Cars:	A	B		B																																																																																																	
a.	↓	→																																																																																																			
b.	↘	↘																																																																																																			
c.	↙	↘																																																																																																			
d.	no motion	↘																																																																																																			
Riders:	A	B		B																																																																																																	
a.	↓	→																																																																																																			
b.	↘	↘																																																																																																			
c.	↙	↘																																																																																																			
d.	↓	↓																																																																																																			
Car:	A			B																																																																																																	
a.	→																																																																																																				
b.	←																																																																																																				
c.	no motion																																																																																																				
Rider:	A			B																																																																																																	
a.	→																																																																																																				
b.	←																																																																																																				
c.	no motion																																																																																																				



## Bumper Cars Ride Measurements

Answer the following questions in complete sentences.

1. During collision 2, is kinetic energy (KE) conserved? Explain why or why not. \_\_\_\_\_

---

---

---

---

---

2. In collision 3, KE is not conserved. If the total energy of the system is conserved, where did the KE go? \_\_\_\_\_

---

---

---

---

3. During collision 4, is KE conserved? Explain why or why not.

---

---

---

---



*Bumper cars can be used to demonstrate Newton's laws of motion and energy transformations.*



# Roller Coasters—Floater Hills

## Ground Measurements

Locate a medium-sized hill on a coaster ride.

- Estimate the height of the hill from the ground to the peak (A) by using the design of the structures. See the Basic Skills section if you have forgotten how to do this. Show your work in the box.
- Use stepping to find the hill base distance B to C (low points before and after the hill).
  - Your steps for 30 meters \_\_\_\_\_
  - Number of steps taken \_\_\_\_\_
  - Hill base distance (B to C) \_\_\_\_\_  
(Hint: Multiply the number of steps taken by 30 meters and divide this answer by the number of steps you take for 30 meters.)
- Check the ride information sign by the entrance of the ride to find the total distance of the coaster.
  - Distance in feet \_\_\_\_\_
  - Convert your answer to meters \_\_\_\_\_
- Calculate the average speed of the ride. Stand by the start and exit area. Take note of the number or color of the car you will time. Time the ride from when the train of cars leaves the start gate until it returns. Time three cars from start to finish. Be sure to convert the time to seconds. Fill in the table below.

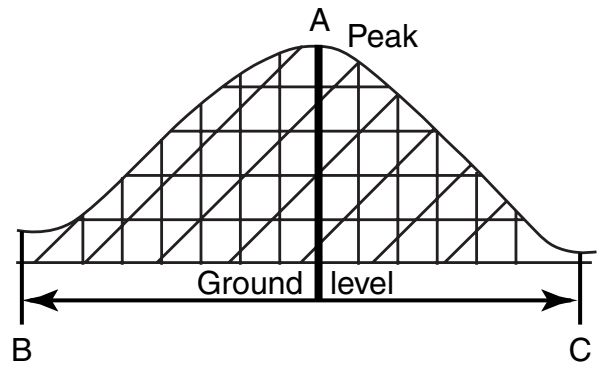

Show your work here.

	Car 1	Car 2	Car 3	Average time, s	Total ride distance, m	Average speed, m/s
Total ride						



## Roller Coasters—Floater Hills Ride Measurements



*The Timber Terror is located at Silverwood in Athol, Idaho.*

Take the accelerometer on the ride, paying attention to the g levels. The ride is very fast so it helps if you call out the g measurements to your partner as you go up and down the hills and around the curves.

1. Where did you experience microgravity or low g? Check all that apply.

- around curves
- going up and over the top of the hills
- going down and into a low point or valley

2. What was the lowest g reading? \_\_\_\_\_

3. Where did you experience high-g levels? Check all that apply.

- around curves
- going up and over the top of the hills
- going down and into a low point or valley

4. What was the highest g reading? \_\_\_\_\_



*This floating hill is located near the end of Phantom's Revenge. It is located in Kennywood Park, West Mifflin, Pennsylvania.*





## Carousels Ground Measurements

Determine the revolutions per minute of the carousel.

1. Stand on the ground in front of the carousel and locate a particular spot on the ride. Make sure that you have a way to remember that spot. Position yourself directly in front of it.
2. If the ride is not moving, wait until it begins and has made several turns. When the point that you have selected is directly in front of you, start your stopwatch and keep it running for 5 revolutions. Total time for 5 revolutions in seconds: \_\_\_\_\_
4. Calculate the time for 1 revolution. This is called the period of rotation of the ride. Time for 1 revolution (period of rotation): \_\_\_\_\_
5. To find the revolutions per minute of the ride, divide 60 by the period of rotation, since there are 60 seconds in 1 minute. Revolutions per minute: \_\_\_\_\_



Measuring the angle of the carousel pole

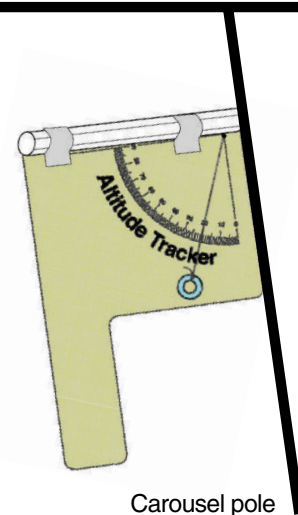

Carousel pole

## Carousels Ride Measurements

1. There is a “lean” of the benches and on the poles that support the animals. When the ride is stationary, use your altitude tracker to determine the angle that an animal in the outer row makes with the vertical. While holding the tracker vertically, place it against the animal’s support pole, reading the angle between the center of the pole and the zero mark on the tracker. Angle = \_\_\_\_\_
2. Measure the angle that an animal in the inner row makes with the vertical. Angle = \_\_\_\_\_
3. Which animal has a larger angle, the one located in the inner row or the one in the outer row?  
\_\_\_\_\_
4. Do the same measurements on the very same animals while the ride is in motion.  
Inner angle: \_\_\_\_\_ Outer angle: \_\_\_\_\_
5. How do the results of angle measurements compare when looking at stationary ride animals versus moving ride animals? Explain your answer. \_\_\_\_\_  
\_\_\_\_\_  
\_\_\_\_\_



## Roller Coasters—Loops Ground Measurements



Figure 1.

The loops of a roller coaster are not circles; they are called clothoid loops. Circular loops require a higher amount of speed to keep the riders from falling out when they are upside down. Roller coasters use clothoid loops, which have a smaller radius at the top of the loop, and a longer radius where the cars enter and exit the loop (see fig. 1).

Why do you think roller coasters use clothoid loops instead of circular loops? \_\_\_\_\_

\_\_\_\_\_

\_\_\_\_\_

## Roller Coasters—Loops Ride Measurements

- When riding in a loop at high speeds, pay close attention to whether you feel heavier, lighter, or normal in your seat. Refer to figure 2 to assist you when completing the following table (select one per row).

Location of ride	Heavier	Lighter	Normal
Going into loop (A)			
At top of loop (B)			
Going out of loop (C)			

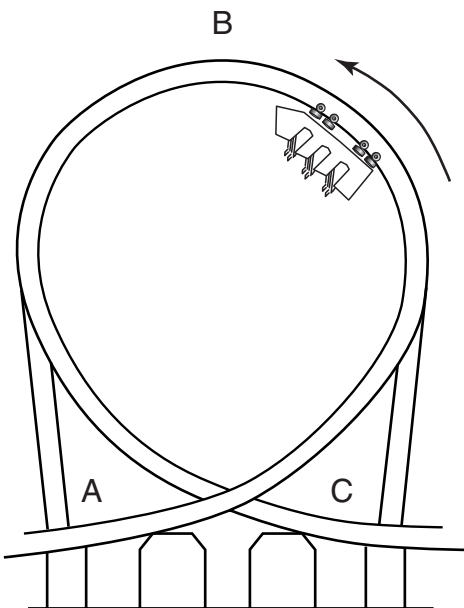

Figure 2.

- A rider experiences a different sensation when sitting in the front than sitting in the back. First, ride the coaster seated in a front car. Secondly, ride the coaster again seated in a back car. Finally, try sitting in the middle of the coaster. In which seat location did you experience faster speeds at the top of the loop?

\_\_\_\_\_

- If you had a hat on your head while riding and your hat fell off as the coaster car approached the top of the loop, which way would it go, ignoring air resistance? (Caution: Do not actually try this on the ride!)

a) Draw the path of the hat by drawing an arrow on figure 2.

b) Which of Newton's laws applies to the hat when it leaves your head. State the complete law below.

\_\_\_\_\_

\_\_\_\_\_

\_\_\_\_\_





*The Kumba, located in Busch Gardens in Tampa, Florida, has many high-g loops within the ride.*

## Example of Two Roller Coaster Loops



*The Shock Wave, built in 1978, was the first coaster to feature two consecutive vertical loops. It still runs without shoulder restraints. It is located at Six Flags Over Texas, Arlington, Texas.*



## Pendulum Rides Ground Measurements

Stand facing the ride, lined up with the center of the pendulum. See point B in the figure below.

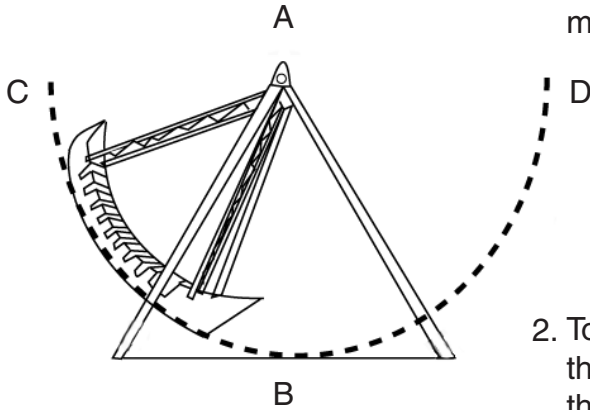

1. Estimate the height of point A using the “scale drawing method.” Show your work, including the diagram.

2. To determine the radius of the pendulum ride, find the distance that point B is above the ground. Subtract this number from the answer found in number 1 above. Show your work.

3. The time of a simple pendulum’s swing can be expressed as  $t = 2\pi \sqrt{\frac{l}{g}}$ , where  $t$  = time for one full swing in second (period),  $l$  = length of pendulum’s radius,  $\pi \approx 3.14$ ,  $g = 9.8$  meters/second<sup>2</sup>. Calculate the expected time for one full swing (from C to D to C) for the ride. Show your work.

4. Wait until the ride reaches the top of the swing (point C or D) then begin counting the number of swings, or vibrations (C–D–C) that occur in 30 seconds. Estimate any fractional portions of the swing. Do three trials and calculate an average. Fill in the table below.

	Trial 1	Trial 2	Trial 3	Average
Number of swings/ vibrations in 30 seconds				

5. Calculate the average time for a swing/vibration by dividing 30 seconds by the average number of swings. The average number of swings was found in number 4 above.

---

6. Explain why the pendulum ride is not actually a true pendulum that falls due to gravity.

---



---



---



## Pendulum Rides Ride Measurements

1. Take the accelerometer on the ride. Label figure 1 where you experienced
  - a. The highest g, lowest g, and 1 g
  - b. Your weight to be normal, heavier, or lighter

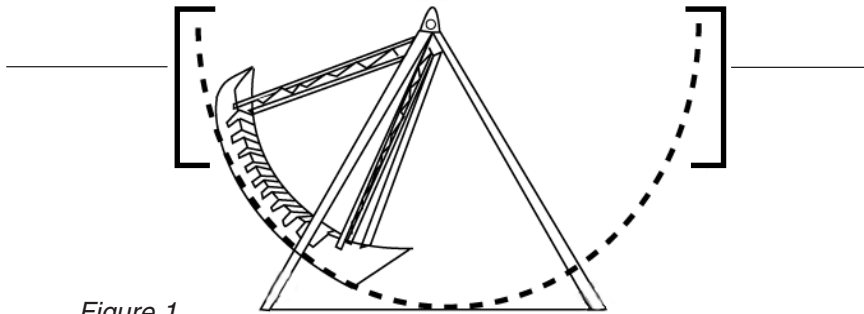

Figure 1.



The Skymaster is located in PNE Playland, Vancouver, British Columbia, Canada.

2. A daring rider wants to experience the greatest range of g loads. Draw two arrows in figure 2 to indicate where he or she should sit. Hint: Consider working with another group or two, each sitting in different rows. Compare which rows give the highest and lowest accelerometer readings.
3. The KC-135 flies in a parabolic path, similar to the pendulum ride. Draw the entire path of two KC-135 parabolas in the box below. Circle the portion that is similar to the path of the pendulum ride.

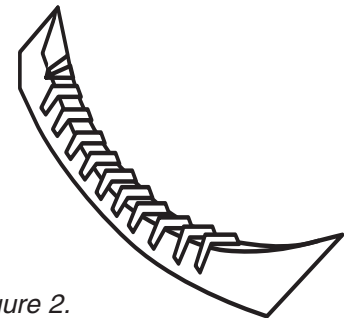

Figure 2.



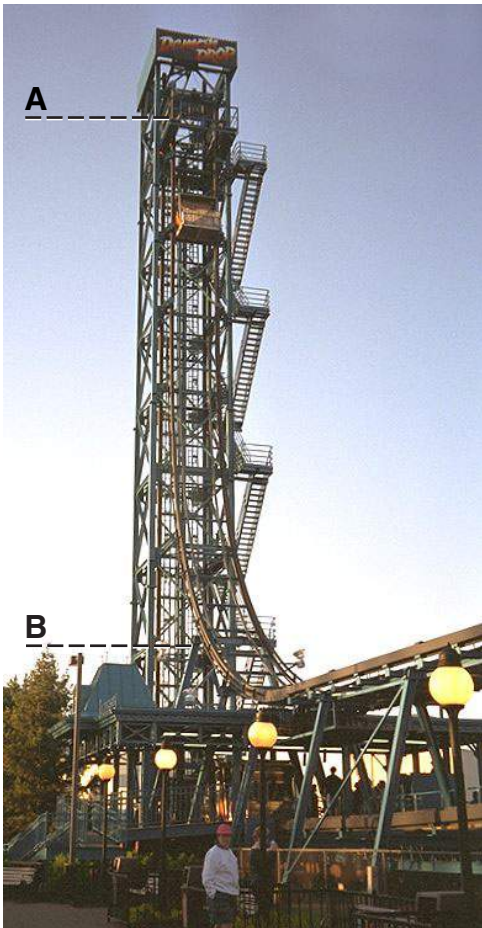

Figure 1.

## Free-Fall Rides—Nonattending Students Ground Measurements

The following measurements were taken near the ride entrance. Use them to complete the worksheet.

- Using figure 1, estimate how high the ride car actually goes (point A) using the scale drawing method of angles and point of intersection. If you have forgotten how to do this, see the Basic Skills section. Show your work below.

**Eye height = 1.4 meters, first angle =  $29^\circ$ ,  
second angle =  $20^\circ$**

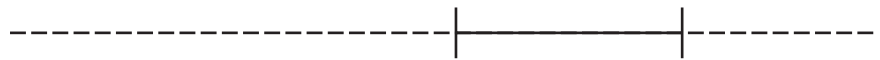

- The height of point B is approximately 3.6 meters above the ground. Calculate the distance between point A and point B. Show your work in the space below.

- Stand by the exit area to calculate the average speed of the ride.
  - Time the lift from the start point to the highest point (point A in figure 1) the car travels. Time three different cars as they travel from the start to point A. Fill in the table below.
  - Time the fall from point A to point B. Stop the timer as soon as the car reaches the low point of the ride (point B in fig. 1). Don't wait for the ride to come to a complete stop. Fill in the table below.

	Time trial 1	Time trial 2	Time trial 3	Average time	Distance using figure 1 above	Average speed, $s=d/t$
Lift to A	<b>7.57 s</b>	<b>7.64 s</b>	<b>7.37 s</b>			
Fall from A to B	<b>3.45 s</b>	<b>3.61 s</b>	<b>3.59 s</b>			



## Free-Fall Rides—Nonattending Students Ride Measurements

When measuring the end of the fall, make sure that you measure the g's before the ride bends away from the vertical. Always hold the accelerometer so that it is vertical, or the measurements will not be correct.

1. If you were to take the accelerometer on the ride to measure the accelerations (g's) during the ride, where would you experience various g levels?
2. Complete column g in the data table below.
3. Indicate with an "X" which of the four locations below have a maximum kinetic energy (KE), maximum potential energy (PE), minimum KE, or minimum PE. There should be only one X in each column. That is, there is only one location (either during the lift, at the top of the ride, during the fall, or the end of the fall) in which there is a maximum KE. Remember, KE is energy of motion and PE is energy of position.

	g	Maximum KE	Maximum PE	Minimum KE	Minimum PE
During the lift					
At the top of the ride					
During the fall					
End of the fall					



## Roller Coasters—Initial Hill—Nonattending Students Ground Measurements

Use the following data found from a coaster that has an initial hill that can be measured using the estimation techniques you are familiar with.

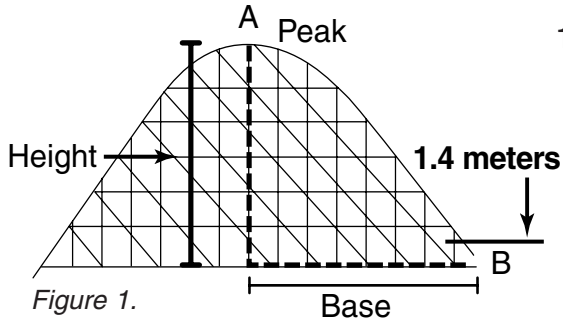

1. Estimate the height of the first hill from the ground by using the design of the structures. See the Basic Skills section if you have forgotten how to do it. Show your work below.

**Eye level height = 1.4 meters,  
fractional part = 8/10, number of structures = six**

2. Find the base length of the hill going down, from point A to point B, by stepping (see fig. 1).

**Stepping distance is 30 meters = 39 steps  
the base of the hill = 32 steps**

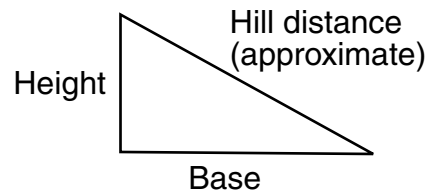

Figure 2.

3. Calculate the approximate hill distance by using the Pythagorean theorem. (Note, this is an approximation of the distance down the first hill because the track is curved at the top and bottom.) Show your work.

$$(\text{base}^2 + \text{height}^2 = \text{hill distance}^2)$$

4. Time the roller coaster going down the first hill from point A to point B as shown in figure 1. Do this three times and fill in the data table below.
5. Calculate the average speed of the cars down the first hill. First find the average time of your three trials, and then calculate ( $s = d/t$ ). Fill in data table below.

	Time trial 1	Time trial 2	Time trial 3	Average time	Distance, m	Speed, m/s
From A to B	<b>3.0 s</b>	<b>2.6 s</b>	<b>2.8 s</b>			





## Roller Coasters—Initial Hill—Nonattending Students Ride Measurements

The accelerometer was taken on a ride, with close attention paid to observing the g measurements.

1. When do microgravity ( $<1$  g) moments occur (up and over a hill, down a hill and into a valley, up a hill, down a hill, over the crest of a hill, going through a valley, around curves)?

---

---

---

2. What was the highest g-level reading you observed? Where was it (up and over a hill, down a hill and into a valley, up a hill, down a hill, over the crest of a hill, going through a valley, around curves)?

---

---

---



# Bumper Cars—Nonattending Students

## Ride Measurements

For each collision shown below, circle the appropriate set of arrows to indicate which direction the cars and riders move immediately after impact. Assume the masses of riders A and B are equal.

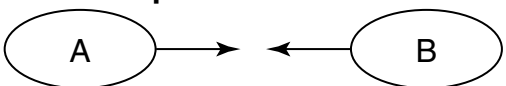
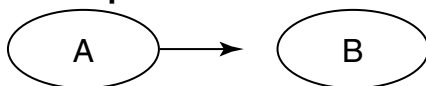
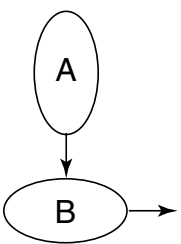
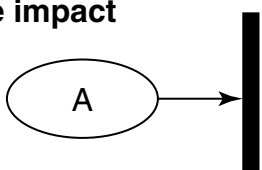
<p><b>1. Head-on collision</b></p> <p><b>Before impact</b></p>  <p><b>After impact</b></p> <table style="width: 100%; border: none;"> <tr> <td style="width: 50%;">Cars: A</td> <td style="width: 50%;">B</td> </tr> <tr> <td>a. </td> <td></td> </tr> <tr> <td>b. </td> <td>no motion</td> </tr> <tr> <td>c. </td> <td></td> </tr> <tr> <td>d. no motion</td> <td></td> </tr> </table> <table style="width: 100%; border: none;"> <tr> <td style="width: 50%;">Riders: A</td> <td style="width: 50%;">B</td> </tr> <tr> <td>a. </td> <td></td> </tr> <tr> <td>b. </td> <td>no motion</td> </tr> <tr> <td>c. </td> <td></td> </tr> <tr> <td>d. no motion</td> <td></td> </tr> </table>	Cars: A	B	a.		b.	no motion	c.		d. no motion		Riders: A	B	a.		b.	no motion	c.		d. no motion		<p><b>2. Rear-end collision</b></p> <p><b>Before impact</b></p>  <p><b>After impact</b></p> <table style="width: 100%; border: none;"> <tr> <td style="width: 50%;">Cars: A</td> <td style="width: 50%;">B</td> </tr> <tr> <td>a. </td> <td>no motion</td> </tr> <tr> <td>b. no motion</td> <td></td> </tr> <tr> <td>c. </td> <td></td> </tr> <tr> <td>d. no motion</td> <td></td> </tr> </table> <table style="width: 100%; border: none;"> <tr> <td style="width: 50%;">Riders: A</td> <td style="width: 50%;">B</td> </tr> <tr> <td>a. </td> <td></td> </tr> <tr> <td>b. </td> <td>no motion</td> </tr> <tr> <td>c. </td> <td></td> </tr> <tr> <td>d. no motion</td> <td></td> </tr> </table>	Cars: A	B	a.	no motion	b. no motion		c.		d. no motion		Riders: A	B	a.		b.	no motion	c.		d. no motion	
Cars: A	B																																								
a.																																									
b.	no motion																																								
c.																																									
d. no motion																																									
Riders: A	B																																								
a.																																									
b.	no motion																																								
c.																																									
d. no motion																																									
Cars: A	B																																								
a.	no motion																																								
b. no motion																																									
c.																																									
d. no motion																																									
Riders: A	B																																								
a.																																									
b.	no motion																																								
c.																																									
d. no motion																																									
<p><b>3. Side-impact collision</b></p> <p><b>Before impact</b></p>  <p><b>After impact</b></p> <table style="width: 100%; border: none;"> <tr> <td style="width: 50%;">Cars: A</td> <td style="width: 50%;">B</td> </tr> <tr> <td>a. </td> <td></td> </tr> <tr> <td>b. </td> <td></td> </tr> <tr> <td>c. </td> <td></td> </tr> <tr> <td>d. no motion</td> <td></td> </tr> </table> <table style="width: 100%; border: none;"> <tr> <td style="width: 50%;">Riders: A</td> <td style="width: 50%;">B</td> </tr> <tr> <td>a. </td> <td></td> </tr> <tr> <td>b. </td> <td></td> </tr> <tr> <td>c. </td> <td></td> </tr> <tr> <td>d. </td> <td></td> </tr> </table>	Cars: A	B	a.		b.		c.		d. no motion		Riders: A	B	a.		b.		c.		d.		<p><b>4. Car hits wall</b></p> <p><b>Before impact</b></p>  <p><b>After impact</b></p> <table style="width: 100%; border: none;"> <tr> <td style="width: 50%;">Car: A</td> <td style="width: 50%;"></td> </tr> <tr> <td>a. </td> <td></td> </tr> <tr> <td>b. </td> <td></td> </tr> <tr> <td>c. no motion</td> <td></td> </tr> </table> <table style="width: 100%; border: none;"> <tr> <td style="width: 50%;">Rider: A</td> <td style="width: 50%;"></td> </tr> <tr> <td>a. </td> <td></td> </tr> <tr> <td>b. </td> <td></td> </tr> <tr> <td>c. no motion</td> <td></td> </tr> </table>	Car: A		a.		b.		c. no motion		Rider: A		a.		b.		c. no motion					
Cars: A	B																																								
a.																																									
b.																																									
c.																																									
d. no motion																																									
Riders: A	B																																								
a.																																									
b.																																									
c.																																									
d.																																									
Car: A																																									
a.																																									
b.																																									
c. no motion																																									
Rider: A																																									
a.																																									
b.																																									
c. no motion																																									



## Bumper Cars—Nonattending Students Ride Measurements

Answer the following questions in complete sentences.

1. During collision 2, is kinetic energy (KE) conserved? Explain why or why not. \_\_\_\_\_

---

---

---

---

---

---

2. In collision 3, KE is not conserved. If the total energy of the system is conserved, where did the KE go?

---

---

---

---

---

---

3. During collision 4, is KE conserved? Explain why or why not.

---

---

---

---

---

---



## Roller Coasters—Floater Hills—Nonattending Students Ground Measurements

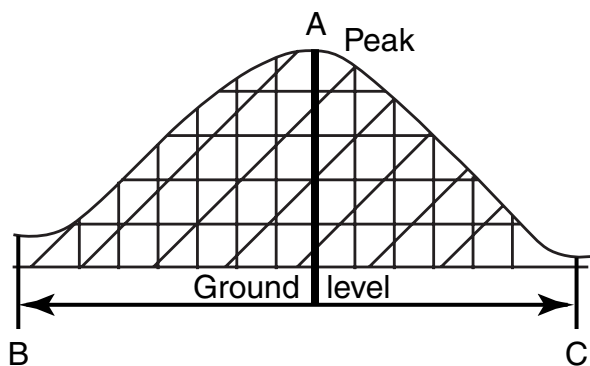

Show your work here.  
**Eye level height = 1.4 meters**  
**fractional part = 4/10**  
**number of structures = five**

Students located a medium-sized hill on a coaster ride.

- Estimate the height of the hill from the ground to the peak (A) by using the design of the structures. See the Basic Skills section if you have forgotten how to do this. Show your work in the box.
- Use stepping to find the hill base distance B to C (low points before and after the hill.)
  - Your steps for 30 meters **39**
  - Number of steps taken **82**
  - Hill base distance (B to C) \_\_\_\_\_  
 (Hint: Multiply the number of steps taken by 30 meters and divide this answer by the number of steps you take for 30 meters.)
- Check the ride information sign by the entrance of the ride to find the total distance of the coaster.
  - Distance in feet **3935**
  - Convert your answer to meters \_\_\_\_\_
- Calculate the average speed of the ride. Stand by the start and exit area. Take note of the number or color of the car you will time. Time the ride from when the train of cars leaves the start gate until it returns. Time three cars from start to finish. Be sure to convert the time to seconds. Fill in the table below.

	Car 1	Car 2	Car 3	Average time, s	Total ride distance, m	Average speed, m/s
Total ride	<b>146 s</b>	<b>152 s</b>	<b>144 s</b>			



## Roller Coasters—Floater Hills—Nonattending Students Ride Measurements

If you were to take the accelerometer on the ride, paying attention to the g levels, you would experience various g levels.

1. Where would you experience microgravity or low g? Check all that apply.

- around curves
- going up and over the top of the hills
- going down and into a low point or valley

2. What would be the lowest g reading? \_\_\_\_\_

3. Where would you experience high-g levels? Check all that apply.

- around curves
- going up and over the top of the hills
- going down and into a low point or valley

4. What would be the highest g reading? \_\_\_\_\_





Measuring the angle of the carousel pole

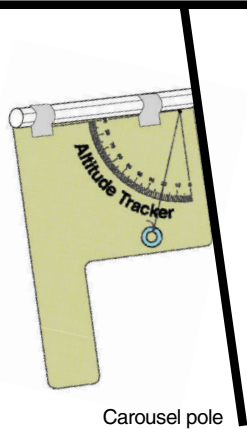

Carousel pole

## Carousels—Nonattending Students Ground Measurements

Determine the revolutions per minute of the carousel.

1. Stand on the ground in front of the carousel and locate a particular spot on the ride. Make sure that you have a way to remember that spot. Position yourself directly in front of it.
2. If the ride is not moving, wait until it begins and has made several turns. When the point that you have selected is directly in front of you, start your stopwatch and keep it running for 5 revolutions. Total time for 5 revolutions in seconds: 90
4. Calculate the time for 1 revolution. This is called the period of rotation of the ride. Time for 1 revolution (period of rotation): \_\_\_\_\_
5. To find the revolutions per minute of the ride, divide 60 by the period of rotation, since there are 60 seconds in 1 minute. Revolutions per minute: \_\_\_\_\_

## Carousels—Nonattending Students Ride Measurements

1. There is a “lean” of the benches and on the poles that support the animals. When the ride is stationary, use your altitude tracker to determine the angle that an animal in the outer row makes with the vertical. While holding the tracker vertically, place it against the animal’s support pole, reading the angle between the center of the pole and the zero mark on the tracker. Angle = 8°
2. Measure the angle that an animal in the inner row makes with the vertical. Angle = 3°
3. Which animal has a larger angle, the one located in the inner row or the one in the outer row?  
\_\_\_\_\_
4. Do the same measurements on the very same animals while the ride is in motion.  
Inner angle: 0° Outer angle: 0°
5. How do the results of angle measurements compare when looking at stationary ride animals versus moving ride animals? Explain your answer. \_\_\_\_\_  
\_\_\_\_\_  
\_\_\_\_\_



## Roller Coasters—Loops—Nonattending Students Ground Measurements

The loops of a roller coaster are not circles; they are called clothoid loops. Circular loops require a higher amount of speed to keep the riders from falling out when they are upside down. Roller coasters use clothoid loops, which have a smaller radius at the top of the loop, and a longer radius where the cars enter and exit the loop (see fig. 1).

Why do you think roller coasters use clothoid loops instead of circular loops? \_\_\_\_\_

\_\_\_\_\_

\_\_\_\_\_



Figure 1.

## Roller Coasters—Loops—Nonattending Students Ride Measurements

- If you rode a coaster loop at high speeds and paid close attention to whether you felt heavier, lighter, or normal in your seat, how do you think you would feel in the various locations? Refer to figure 2 to assist you when completing the following table (select one per row).

Location of ride	Heavier	Lighter	Normal
Going into loop (A)			
At top of loop (B)			
Going out of loop (C)			

- A rider experiences a different sensation when sitting in the front than sitting in the back. First, one would ride the coaster seated in a front car. Second, he or she would ride the coaster again seated in a back car. Finally, the rider would try sitting in the middle of the coaster. In which seat location do you think the rider would experience faster speeds at the top of the loop?

\_\_\_\_\_

- If you had a hat on your head while riding and your hat fell off as the coaster car approached the top of the loop, which way would it go, ignoring air resistance? (Caution: Do not actually try this on the ride!)

- Draw the path of the hat by drawing an arrow on figure 2.
- Which of Newton's laws applies to the hat when it leaves your head. State the complete law below.

\_\_\_\_\_

\_\_\_\_\_

\_\_\_\_\_

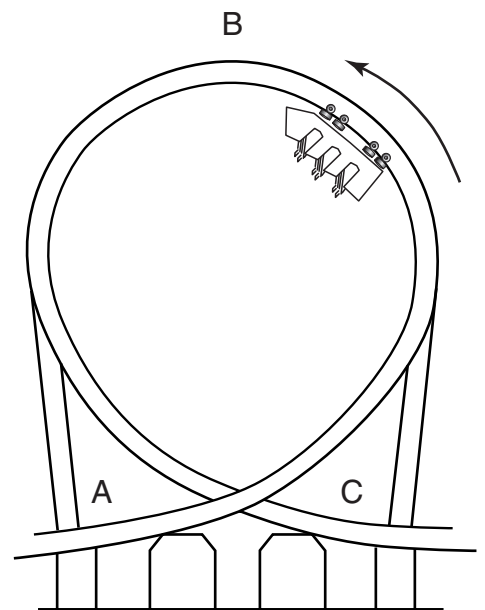

Figure 2.



## Pendulum Rides—Nonattending Students Ground Measurements

Stand facing the ride, lined up with the center of the pendulum. See point B in the figure below.

1. Estimate the height of point A using the “scale drawing method.” Show your work, including the diagram.

**Eye height = 1.4 meters, first angle =  $35^\circ$ ,  
second angle =  $22^\circ$**

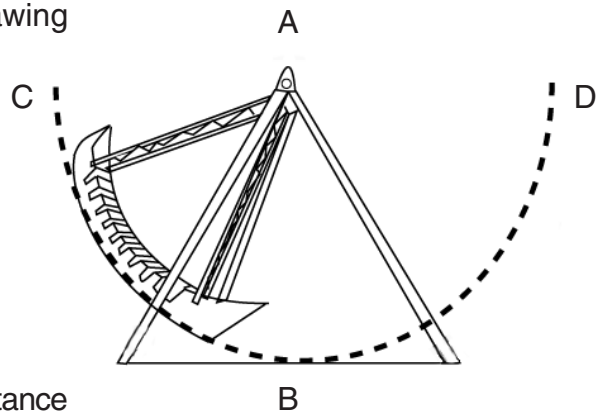

2. To determine the radius of the pendulum ride, find the distance that point B is above the ground. Subtract this number from the answer found in number 1 above. Show your work.

3. The time of a simple pendulum’s swing can be expressed as  $t = 2\pi \sqrt{\frac{l}{g}}$ , where  $t$  = time for one full swing in second (period),  $l$  = length of pendulum’s radius,  $\pi \approx 3.14$ ,  $g = 9.8$  meters/second<sup>2</sup>. Calculate the expected time for one full swing (from C to D to C) for the ride. Show your work.

4. Wait until the ride reaches the top of the swing (point C or D) then begin counting the number of swings, or vibrations (C–D–C) that occur in 30 seconds. Estimate any fractional portions of the swing. Do three trials and calculate an average. Fill in the table below.

	Trial 1	Trial 2	Trial 3	Average
Number of swings/ vibrations in 30 seconds	<b>3.8</b>	<b>3.7</b>	<b>3.9</b>	

5. Calculate the average time for a swing/vibration by dividing 30 seconds by the average number of swings. The average number of swings was found in number 4 above.

---

6. Explain why the pendulum ride is not actually a true pendulum that falls due to gravity.

---



---



---





# Pendulum Rides—Nonattending Students Ride Measurements

1. If you took the accelerometer on the ride with you, where do you think you would experience the following sensations? Label figure 1 where you think you would experience
  - a. The highest g, lowest g, and 1 g
  - b. Your weight to be normal, heavier, or lighter

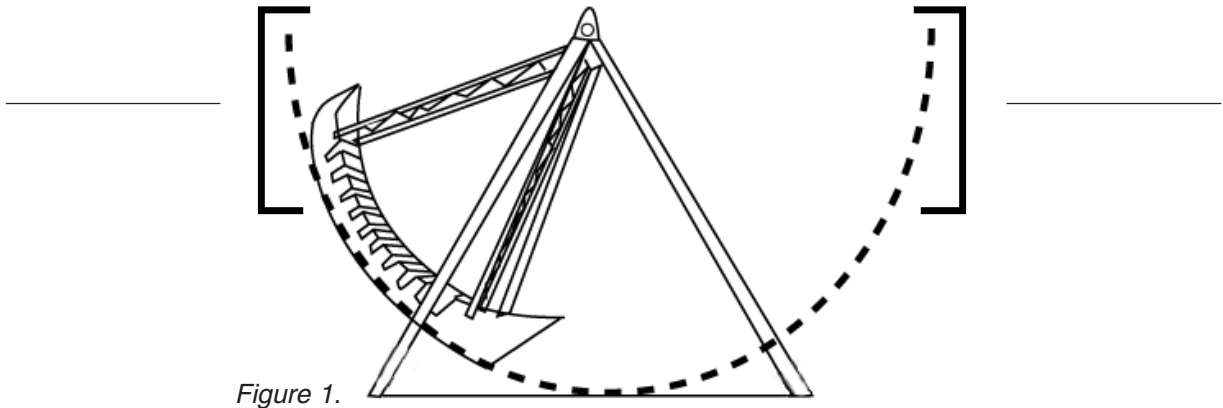

2. A daring rider wants to experience the greatest range of g loads. Draw two arrows in figure 2 to indicate where he or she should sit.

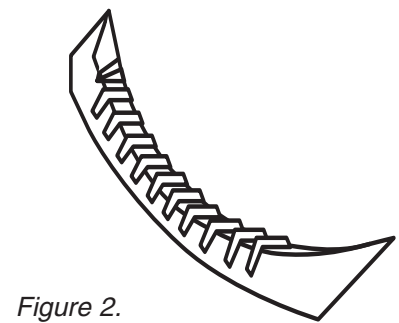

3. The KC-135 flies in a parabolic path, similar to the pendulum ride. Draw the entire path of two KC-135 parabolas in the box below. Circle the portion that is similar to the path of the pendulum ride.



## Pendulums—Part 1—Answer Key

Pendulums swing back and forth in a regular pattern. One back and forth movement is called a vibration. The time it takes to complete one vibration is called the period. This lab tests the effects of different lengths of string on the period of a pendulum swing.

### Task

Test what will happen to the period of a pendulum when the length of the string changes.

### Hypothesis

Predict how you think the string length will affect the period. (Will the period of the pendulum change when you change the length of the string?) Write your prediction here.

As the length of the pendulum decreases, the speed increases. Thus the period or time for each vibration decreases as the length is shortened.

### Procedure

1. Tie the paperclip to the end of a string so that you have 1 meter of string length to work with, measuring from the middle of the paperclip. Allow enough extra string for tying.
2. Attach the top of the string to a ring stand or the edge of a table with tape so the paperclip can hang freely without touching the floor. Remeasure to make sure that the total length is 1 meter.
3. Hang the washer onto the paperclip and pull it to the side at a small angle and release.
4. Count the number of vibrations that occur in 30 seconds. A vibration is one swing out and back.
5. Do three trials and average the results.
6. Record your averages in the table on the next page.
7. Repeat steps 3 through 5, decreasing the string length by 10 centimeters each time. Continue for a total of 10 trials.
8. Make a coordinate graph of the results comparing the average number of vibrations in 30 seconds (y-axis) to the length of the pendulum string (x-axis).

**Don't forget to label!**

### Materials

- Stopwatch
- 1-meter string
- One washer
- Meter stick
- Tape
- Paperclip
- Ring or support stand

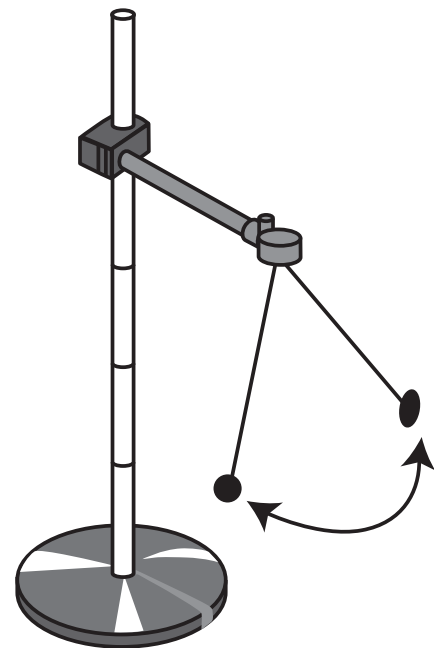

Length of string	10 cm	20 cm	30 cm	40 cm	50 cm	60 cm	70 cm	80 cm	90 cm	100 cm
Average number of vibrations in 30 seconds	47.3	33.4	27.3	23.6	21.1	19.3	17.9	16.7	15	14.9

Title: Average number of vibrations versus length of a pendulum

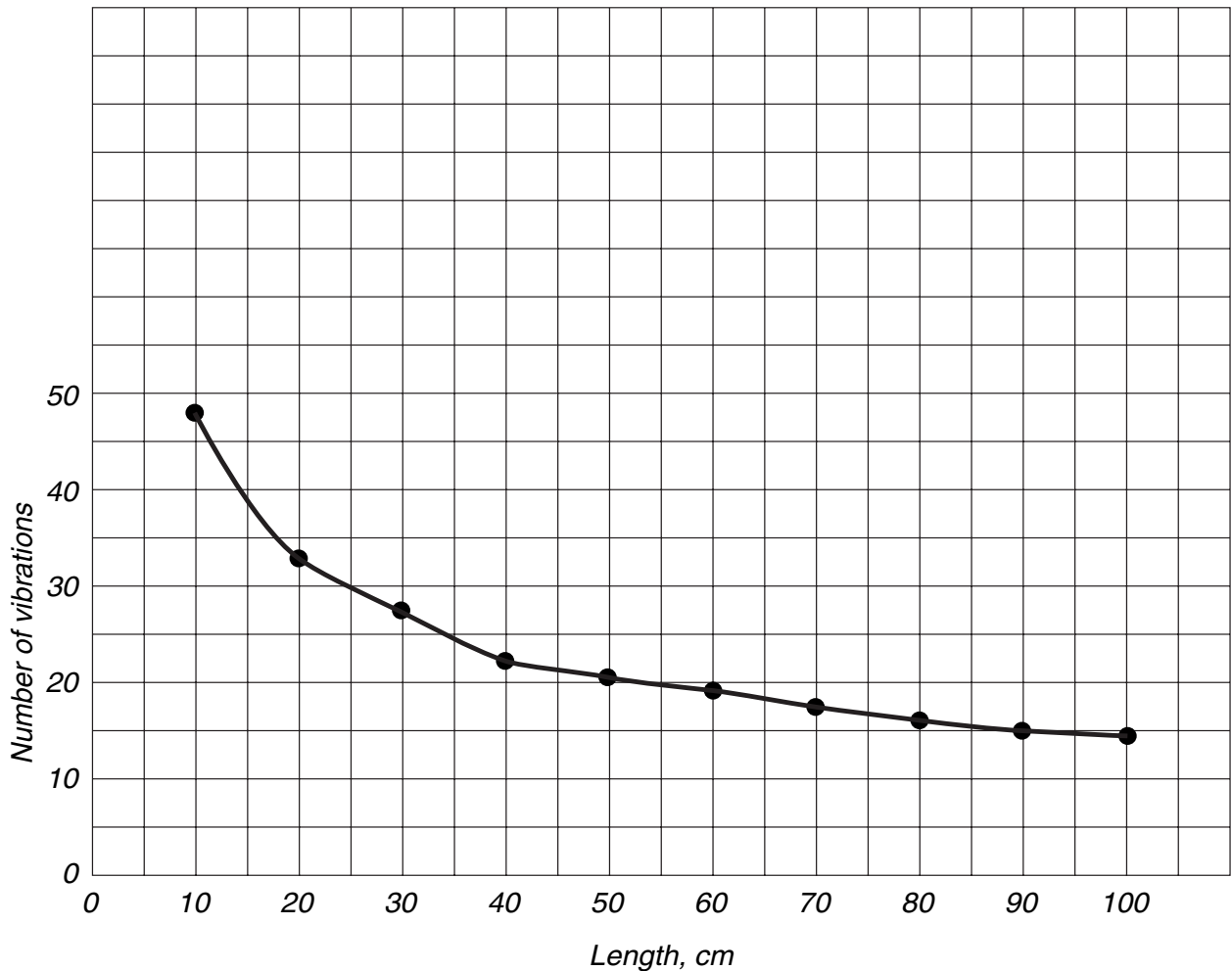

**Conclusion** (Write answers in complete sentences.)

1. What effect does the length of string have on the period of a pendulum? Explain.

*The shorter the length of the pendulum, the shorter the period.*

---



---



---

2. Name three common amusement park rides or other objects that are examples of pendulums in action.

*Examples of pendulums are rides such as the Pirate Ship, the Mirage, the Texas Twister, Time Warp, Ocean Motion. Some objects that are pendulums are a grandfather clock and a child's swing.*

---



---



## Pendulums—Part 2—Answer Key

Pendulums swing back and forth in a regular pattern. One back-and-forth movement is called a vibration or oscillation. The time it takes to complete one vibration is called the period. This lab is going to test the effects of different masses on the period of a pendulum swing.

### Task

Test what will happen to the period of a pendulum when the mass attached to the string changes.

### Hypothesis

Predict how you think the mass attached to the pendulum will affect the period. (Will the period of the pendulum change when you change the mass attached to the string? If so, how? Will more mass cause the period to shorten or increase?) Write your prediction here.

The period of the swing will not be affected by changing the mass.

---



---

### Procedure

1. Glue Velcro® to the outside of the lid of a film canister. Attach one end of a string to the Velcro®. Use enough string so that the total length from the bottom of the film canister to the point of attachment is 60 centimeters, allowing extra string for tying.
2. Tie the top of the string to a ring stand, support rod, or the edge of a table so that the canister can hang freely without touching the floor.
3. Put a washer inside the canister and close the lid. Pull the canister to the side at a small angle and release.
4. As the canister (with the washer inside) swings, count the number of vibrations that occur in 30 seconds. A vibration is one out and back swing.
5. Do this three times and average your results.
6. Record each average in the table on the next page.
7. Repeat steps 3 through 5, adding another washer each time to the canister. Continue for a total of 10 trials.
8. Make a coordinate graph of the results comparing number of vibrations that occur in 30 seconds (y-axis) to the number of washers (x-axis). **Don't forget to label!**

**Materials**

- Stopwatch
- 60-centimeter string
- Ten washers or masses
- Meter stick
- Tape
- Film canister
- Ring or support stand
- Velcro®

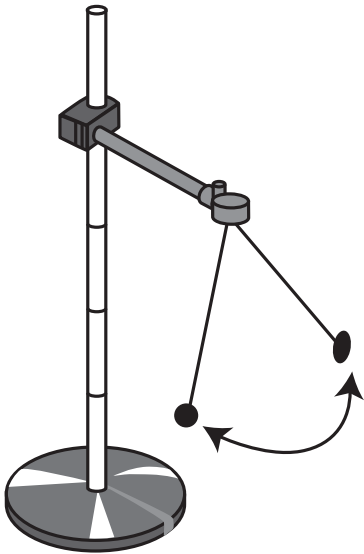

Number of washers	1	2	3	4	5	6	7	8	9	10
Average number of vibrations in 30 seconds	19	19	19	19	19	19	19	19	19	19

Title: Average number of vibrations versus number of washers (mass) of a pendulum

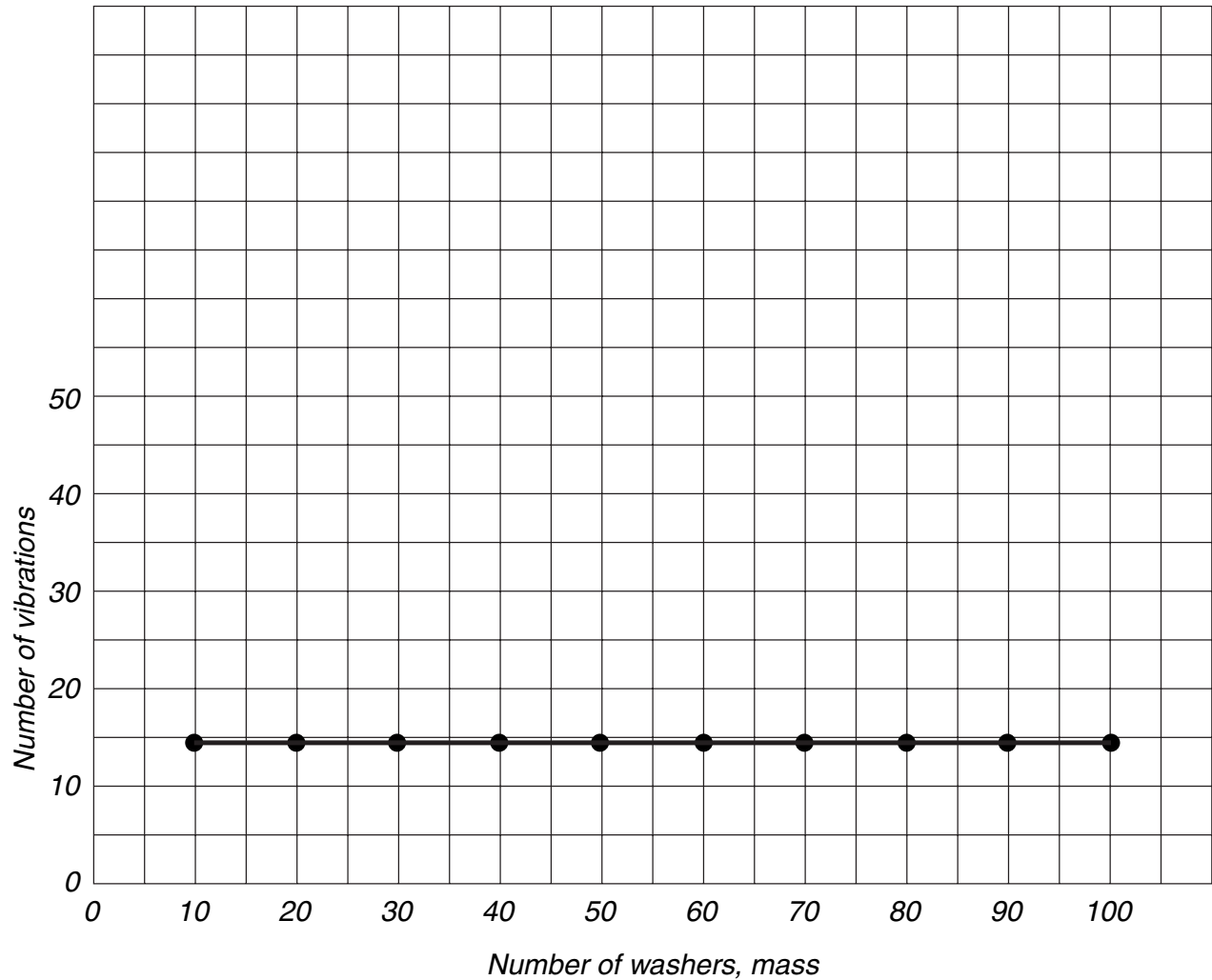

**Conclusion** (Write answers in complete sentences.)

1. What effect does the mass attached to the string have on the period of a pendulum?

*Changing the amount of mass does not affect the period of the pendulum.*

---



---



---

2. Two grandfather clocks are built at factories across town from each other. One is made of bronze and one is made of plastic. Is it possible for the two clocks to keep the same time? Explain.

*It is possible for the two clocks to keep the same time as long as their pendulums are the same length.*

---



---



## Collisions—Part 1—Answer Key

### Task

You will be observing colliding marbles, which demonstrate the conservation of momentum. The momentum of a moving object is the product of its mass and its velocity ( $M = mv$ ). If all of the marbles are identical in mass and size, a moving marble will transfer its momentum to a stationary marble when they collide.

### Materials

- Plastic ruler with center groove (30 centimeters long) or similar items for tracking the marbles, such as ornate wooden molding
- Eight identical marbles

### Parameter

Make sure your marbles are identical in size and mass.

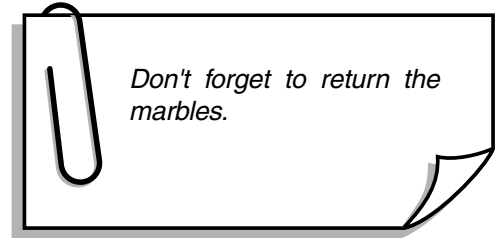
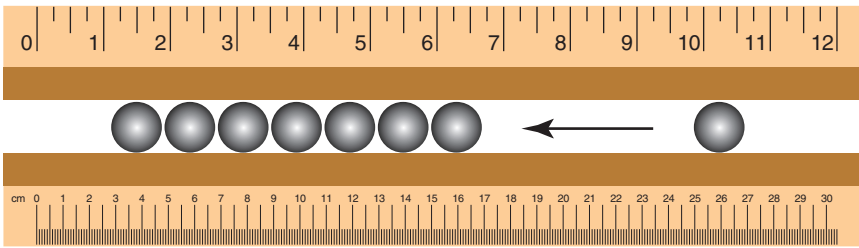

### Procedure

1. Place all eight marbles in the ruler groove next to and touching each other.
2. Pull one of the marbles about 10 centimeters away from the rest and then push it back toward the other marbles, giving it some speed. Note what happens when the marbles collide.
3. Place the marbles back at their original position and pull two marbles about 10 centimeters away from the rest. Push the two marbles together toward the other six marbles so that they collide. Note what happens after the collision.
4. Repeat step 3 with three marbles, then four marbles, and finally, five marbles.

### Conclusion

1. When one marble bumps against the other seven, why does just one marble move away? Momentum is conserved in elastic (frictionless) collisions. One marble impacts the other with a mass times velocity causing another marble of the same mass to move away with the same speed as the impact speed (disregarding friction).
2. Did the other six marbles move much after the first collision? Why? No, they did not. Momentum was transferred from the first marble through the line of marbles to the last marble.
3. How many marbles moved away when you pulled three marbles back and made them collide with the remaining five marbles? Three marbles moved away and two marbles remained stationary.
4. If you were to use a twice-as-massive marble to collide with the seven other marbles of regular mass, would that cause just one marble to move away? Explain. No, in order for momentum to be conserved, the mass times velocity of the initial marble equals the mass times velocity of the marbles that move off. The more massive marble would cause two (or more, depending on how massive the marble is) smaller marbles to move off slowly.
5. Would the end marble also move faster when one is hitting the row with a faster speed? Yes. the mass times velocity of the initial marble equals the mass times velocity of the marbles that move off. The faster the velocity of the incident marble, the faster the end marble will fall off if the masses are equal.



## Collisions—Part 2—Answer Key

### Materials

- Plastic ruler with center groove (30 centimeters long) or similar items for tracking the marbles, such as ornate wooden molding
- Two identical marbles
- Two identical books or boards to use as ramp supports

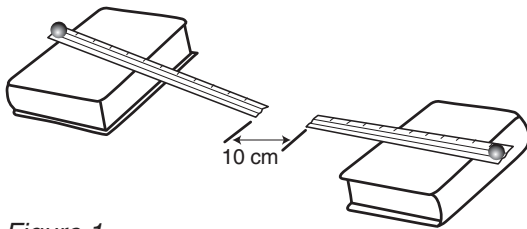

Figure 1.

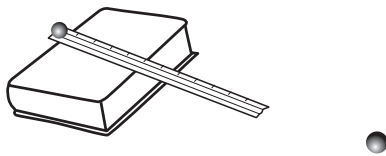

Figure 2.

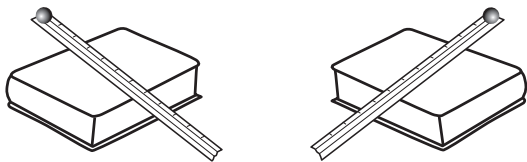

Figure 3.

### Task

You will cause two moving marbles to collide and observe the direction of the movement after collision.

### Parameters

Make sure your marbles are identical in size and mass.

### Procedure

1. Make a ramp using each of the rulers and a support, such as a board or a book.
2. Place the ends of the rulers that are resting on the table facing each other separated by a 10-centimeter distance, as shown in figure 1.
3. Place a marble at the top of each ruler and then release the marbles at the same time. Note and record the direction of movement after the marbles collide. After collision, each marble will rebound backward at the same speed.

---

4. Move the rulers farther apart so that there is 20 centimeters between them. Place a marble at the top of each ruler. Give one of the marbles a push, and let the other marble roll without a push (one fast-moving, one slow-moving). Note and record the differences between this collision and the collision in the previous step. After collision, the fast-moving marble should rebound back at a slower rate, and the slower marble should rebound at a faster rate, due to momentum transfer.

---

5. Place one marble on the table 10 centimeters from the base end of one ruler to be a target. Place the other marble at the top of the ruler ramp, releasing it to hit the target marble. Note and record the direction of movement after the marbles collide (see fig. 2). After collision, the target marble will move forward with the same speed as the incident marble, and the incident marble will stop.

---

6. Change the direction of the rulers so that they will collide and hit perpendicular to each other. Note and record the direction of movement after the marbles collide (see fig. 3). After collision, the marbles will move off in a diagonal path to the original and at a slower speed.

---



7. Remove one of the rulers, placing the other ruler so that it faces the ramp stand directly head-on. Place a marble at the top of the ruler and release it. Note the direction that the marble moves after it collides with the ramp stand (see fig. 4). The marble will rebound directly backward with the same speed of impact.

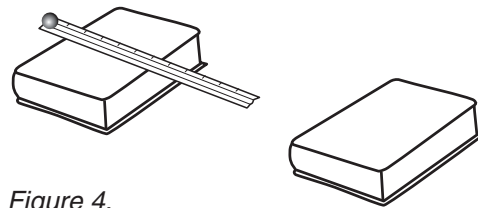

Figure 4.

8. Move the ruler so that it is at an angle with the ramp stand so that the marble will not hit head-on, such as in a side-impact collision (see fig. 5). Note the direction that the marble moves after it collides. The marble will reflect off the ramp stand with the same speed and angle of impact.

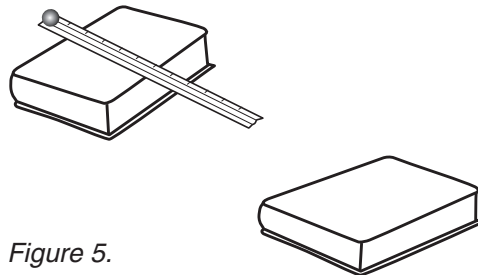

Figure 5.

9. Return the marbles to your teacher when you are finished with this activity.

## Conclusion

1. Describe or illustrate how the marbles moved after they collided head-on in step 3 of the procedure. Is KE conserved? Each marble will move the opposite way after collision with the same speed. KE is conserved.
2. The marble that was pushed has more KE, because it is moving faster. After the collision, which marble has more KE? The slower marble should move the opposite way with a faster speed having more KE, and the faster one should rebound at a slower speed than its original speed, having less KE.
3. Although the bumper car riders are strapped in and do not fly out of the car, their heads are relatively free to move. Two bumper cars have riders that are the same size and mass, but rider A's car is moving faster than rider B's car when the cars collide head-on.
- a. What will be the resulting motion of each rider's head after collision (assuming they stay attached to the bodies)? The riders have the same initial speed as the cars they are riding. The head of the rider in the faster moving car will lose speed and therefore lose KE when rebounding. The head of the slower rider will recoil with a faster speed and thus gain KE when rebounding.
- b. What will be the resulting motion of the cars after the collision? The faster moving car will lose KE when rebounding and transfer the momentum to the slower car, which will gain KE when rebounding.
4. If the marble sitting still at the bottom of the ramp, in step 5 of the procedure, were twice as massive as the marble rolling down the ramp, how would the resulting movement of marbles be different than what you observed? Because it is twice as massive, the target marble will move more slowly than the incident marble. Thus, KE is not conserved.
5. Illustrate or describe the movement of the marbles after the collision that was set up in step 6 of the procedure. Is the KE of the marbles conserved after the collision? The marbles will move off in a diagonal line from the original paths and at a slower speed. KE is not conserved.
6. How is the direction of movement following the collision in step 7 different from that in step 8 of the procedure? The marble will rebound straight back in step 7, while the marble in step 8 will reflect off the ramp at the same angle that it hit. However, both examples illustrate the law of reflection, which states that the angle of incidence equals the angle of reflection.





## Marble Run—Part 1—Answer Key

### Task

To work as a group to build a roller coaster and to diagram the forces of motion and energy transformations that apply to the track.

### Parameters

1. Use 5.49 meters (18 feet) of copper pipe insulation for the track.
2. Select any type of marble, but only one marble. You will be able to make one switch if you want to change marble type.
3. Avoid putting tape on the surface of the track on which the marble rides.
4. This is not a race, so take time to enjoy it.

### Procedure

1. As a group, build a roller coaster that has
  - An initial hill and one additional hill
  - A complete loop
  - A gap where two pieces of track do not touch each other
  - A run that a marble can roll the entire distance of the track (except at the gap)
2. Time five complete marble runs.
3. Sketch the shape of the coaster below.
4. Label the forces that are present during the marble run (include gravitational, centripetal, and frictional).
5. Label energy transformations in your diagram where the potential energy and kinetic energy increases or decreases.

**Materials**

- Three half pieces of copper pipe insulation (gray, spongy); each piece 1.83 meters or 6 feet
- Masking tape
- One marble
- Stopwatch
- Meter stick

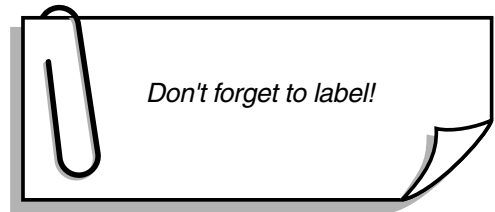

### Roller Coaster Diagram

Average time for 5 trials 2.00 seconds

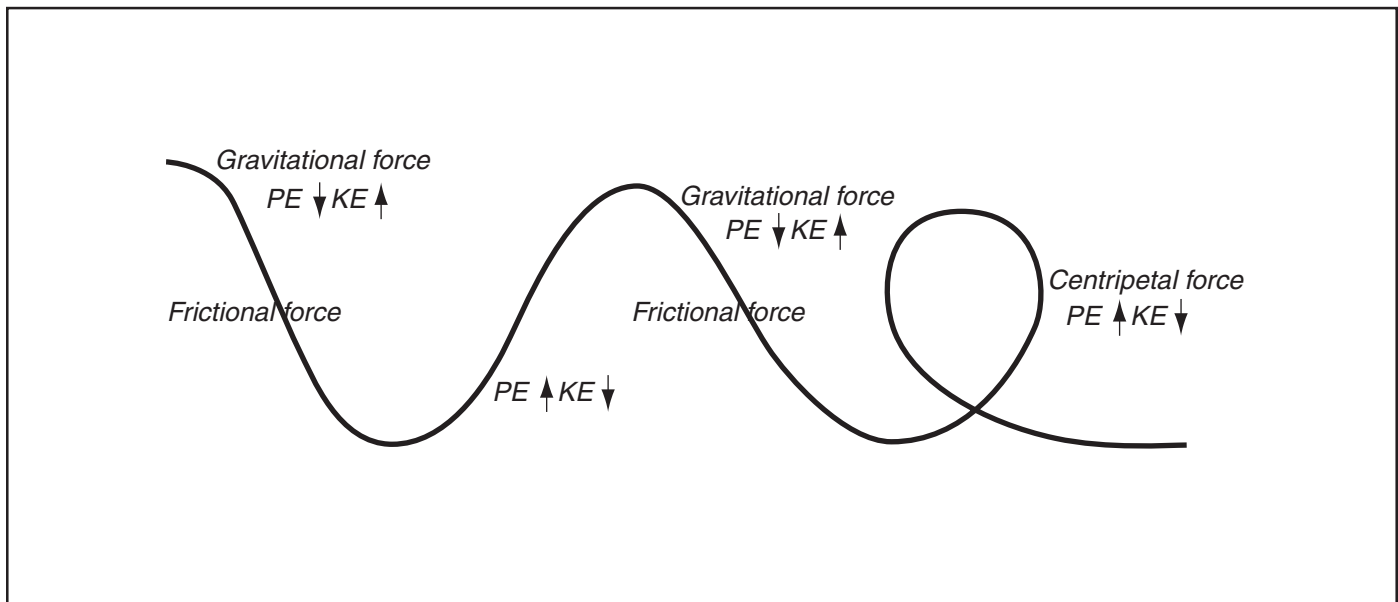

## Marble Run—Part 2—Answer Key

### Materials

- Three half pieces of copper pipe insulation (gray, spongy); each piece 1.83 meters or 6 feet
- Masking tape
- One marble
- Stopwatch
- Meter stick
- Digital camera (optional)

### Task

To work as a group to calculate the average speed of a marble for the team's roller coaster, and to draw the roller coaster to scale.

### Parameters

1. Use 5.49 meters (18 feet) of copper pipe insulation for the track.
2. Select any type of marble, but only one marble. You will be able to make one switch if you want to change marble type.
3. Avoid putting tape on the surface of the track on which the marble rides.

### Procedure

1. As a group, build a roller coaster that has
  - An initial hill and one additional hill
  - A complete loop
  - No gap
  - A run that a marble can roll the entire distance of the track
2. Draw a scale drawing of your roller coaster using the grid graph below.
3. Time the marble from start to finish five times and calculate the average time of travel.
4. Calculate the average speed of the marble.  
( $s = d/t$ , where  $s$  = speed,  $d$  = distance, and  $t$  = time)

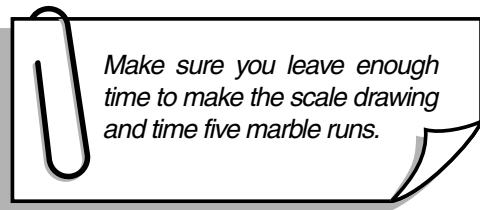

### Scale drawing of roller coaster: 1 block = 20 centimeters

(Suggestion: Photograph your roller coaster with two meter sticks at right angles to represent the X and Y axes. Answers will vary.)

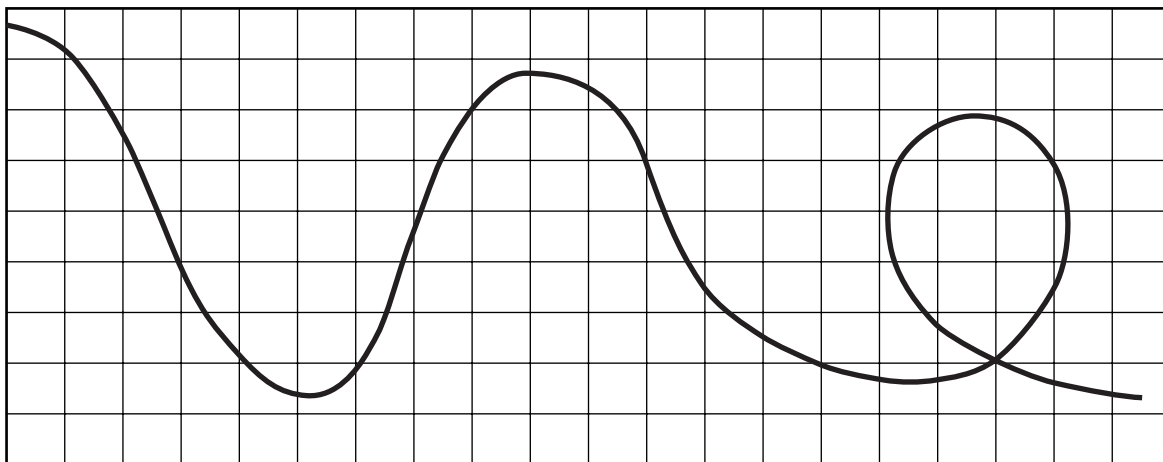

## Data and Calculations

Trial	Distance, m	Time, s	Speed, m/s
1	5.45	2.68	2.03
2	5.45	3.06	1.78
3	5.45	2.78	1.96
4	5.45	2.70	2.02
5	5.45	2.72	2.00
Average	5.45	2.79	1.95



## Marble Run—Part 3—Answer Key

### Materials

- Two half pieces of copper pipe insulation (gray, spongy); each piece 1.83 meters or 6 feet
- Masking tape
- One marble
- Stopwatch
- Meter stick

### Task

To build a roller coaster having a 4-foot hill where the marble stays on the track at all times and to calculate the average speed of the marble for five trials.

### Parameters

1. The first hill must be at a height of 1.22 meters (4 feet) measured from the top of the first hill to the bottom of the first hill.
2. The two additional hills should be as tall as possible.
3. The marble must run the entire length of two pieces of track, 3.66 meters (12 feet).
4. You may add turns or any side motion to the track to increase speed.
5. You may try different types of marbles (small, big, heavy, and light).

### Procedure

1. As a group, build a roller coaster that has
  - Three hills
  - Conditions to allow the marble to remain on the track for the entire run (the marble cannot leave the track at any point)
2. Use a stopwatch to time the marble from the beginning to the end of the track. Repeat for a total of five trials. Record the times below.
3. Calculate the average speed of the marble (speed = distance divided by time). Record below.
4. Draw your roller coaster on the following page and indicate the height of each hill.

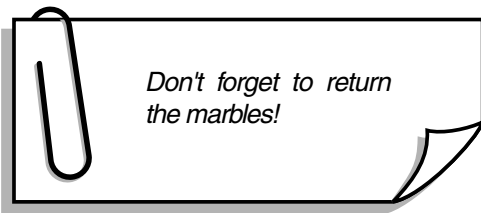

### Data and Calculations (Answers will vary.)

Trial	Distance, m	Time, s	Speed, m/s
1	3.67	3.07	1.20
2	3.67	2.92	1.26
3	3.67	3.00	1.22
4	3.67	2.96	1.24
5	3.67	3.10	1.18
Average	3.67	3.01	1.22



Draw your coaster and label the height of each hill in centimeters. Label the four items listed in the conclusion below.

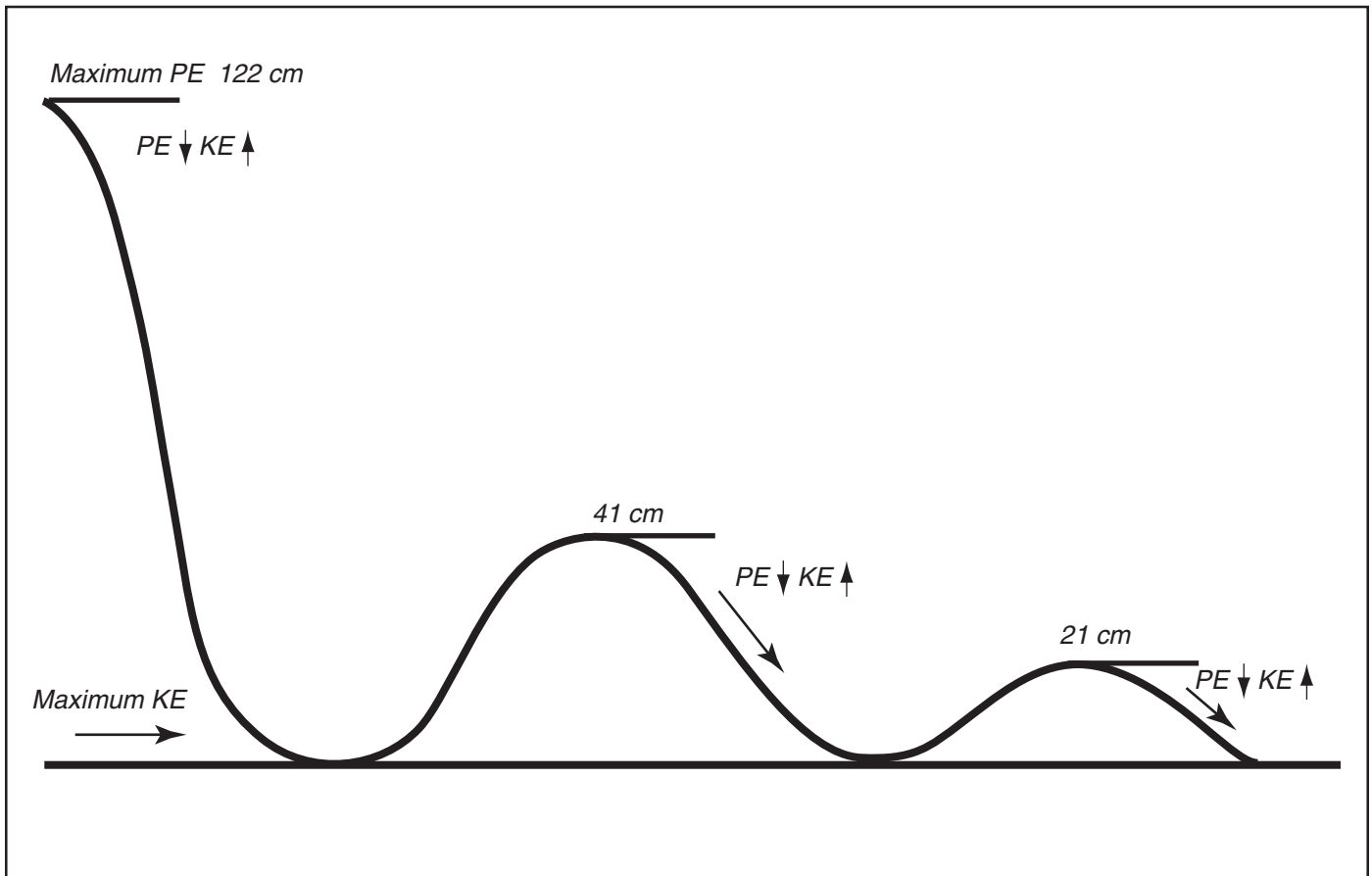

### Conclusion

1. To compare your coaster's potential energy (PE) use with others in the class, what was the combined height of the three hills of your coaster? 184 cm
2. Indicate on your diagram the one location where the PE of the coaster is the greatest (maximum PE). Note, there can only be one of these for the entire coaster.
3. Indicate on your diagram, the area of each hill where PE is decreasing and kinetic energy (KE) is increasing. (PE↓ KE↑)
4. Indicate on your diagram where the KE of the coaster is the highest (maximum KE). Note, there can only be one of these for the entire coaster. When you are finished with your drawing it should have each of the following things labeled:
  - Height of each hill
  - Maximum PE (one only)
  - Areas of PE↓ KE↑
  - Maximum KE (one only)



## Marble Run—Part 4—Answer Key

### Materials

- Two half pieces of copper pipe insulation (gray, spongy); each piece 1.83 meters or 6 feet
- Masking tape
- One marble
- Stopwatch
- Meter stick

One of the most exciting parts of a roller coaster ride is feeling weightless while traveling over a hill. If the coaster can simulate the path of a projectile (like a ball that rolls off a table) the riders will come close to experiencing free fall and will feel weightless.

### Task

As a group, test three different hill formations to find out the optimal hill shape for a roller coaster.

### Parameters

1. Use two pieces of track. The marble must run the entire length of track.
2. The marble cannot leave the track at any time from start to finish.
3. You may try different types of marbles (small, big, heavy, and light), but you must use the same one for all three hills.

*The starting heights will directly affect the speed of the marbles. Each hill shape is optimal for one starting level.*

### Procedure

1. Tape the two tracks together on the bottom.
2. Test three different types of hills (A, B, and C) from three different starting heights (levels 1, 2, and 3). Determine which hill shape is optimal for each starting height. Level 1 is 1.0 meters, level 2 is 0.8 meters, and level 3 is 0.6 meters above the lowest point of the hill (see diagrams below). Note, the height of the middle hill shown in the diagrams are exaggerated for purposes of clarity.

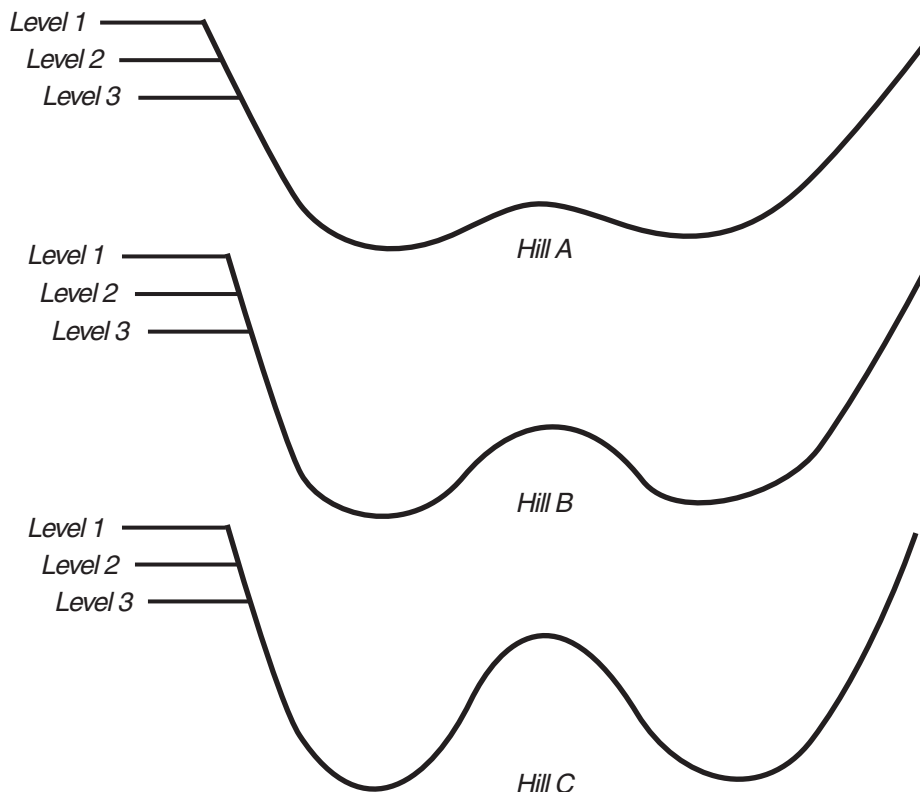

Fill in the table below according to the following descriptions:

**Optimal hill**—The marble is close to free fall for the longest period of time, and is softly caught at the bottom. This is the fastest ride while still staying on the track.

**Safe hill**—The marble stays on the track, but is not traveling as fast as it could, nor does it remain close to free fall for the maximum amount of time.

**Unsafe hill**—The marble leaves the track and possibly hits the other side of the track, or the marble doesn't have enough speed to go over a hill or complete a loop.

Starting height	Hill A	Hill B	Hill C
1	<i>unsafe</i>	<i>unsafe</i>	<i>optimal</i>
2	<i>unsafe</i>	<i>optimal</i>	<i>safe</i>
3	<i>optimal</i>	<i>safe</i>	<i>safe</i>

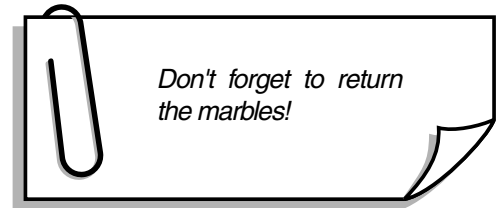

**Conclusion**

- Which hill type is optimal when starting the marble at level 1, and why do you think this is true?  
*Hill C because level 1 has the highest starting point and the highest middle hill requiring the most potential energy.*
- Which hill type is optimal when starting the marble at level 2, and why do you think this is true?  
*Hill B because level 2 is the middle starting point and has the mid-sized hill requiring a medium amount of potential energy.*
- Which hill type is optimal when starting the marble at level 3, and why do you think this is true?  
*Hill A because the lowest starting point has the lowest hill requiring less potential energy.*
- When you ride down a roller coaster hill, does the angle of the slope of the track make a difference in the sensation that you get on the ride? Why?  
*The steeper the slope of the hill, the more frightening the ride, because the track is not supporting the car as much as when it is not as steep. Thus, the rider has the sensation of being in a free-fall environment.*



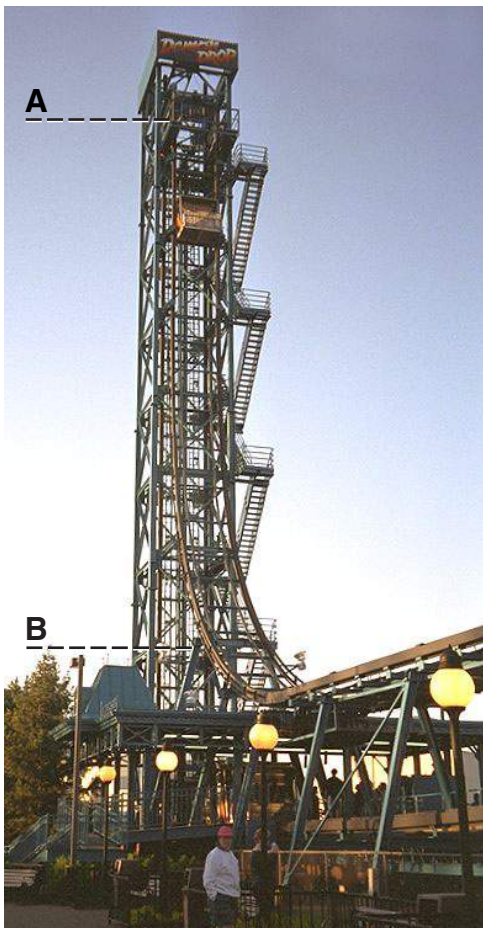
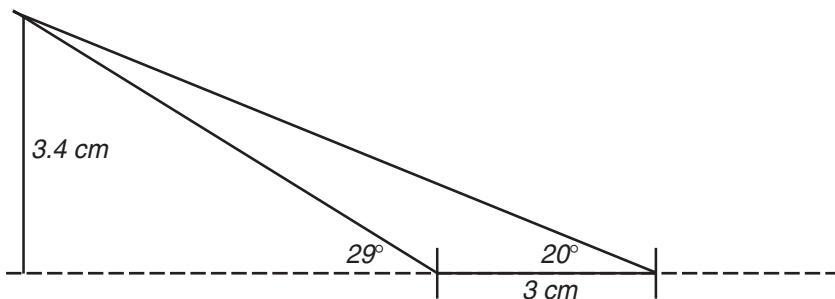

Figure 1.

## Free-Fall Rides Ground Measurements—Answer Key

Stand near the ride entrance to take the following measurements:

- Using figure 1, estimate how high the ride car actually goes (point A) using the scale drawing method of angles and point of intersection. If you forgot how to do this, see the Basic Skills section. Show your work below.



- The height of point B, the end of the ride, is approximately 3.6 meters above the ground. Calculate the distance between point A and point B. Show your work in the space below.

$$35.4 - 3.6 = 31.8 \text{ meters}$$

- Stand by the exit area to calculate the average speed of the ride.
  - Time the lift from the start point to the highest point (point A in figure 1) the car travels. Time three different cars as they travel from the start point to point A. Fill in the table below.
  - Time the fall from point A to point B. Stop the timer as soon as the car reaches the low point of the ride (point B in fig. 1). Don't wait for the ride to come to a complete stop. Fill in the table below.

	Time trial 1	Time trial 2	Time trial 3	Average time	Distance using figure 1 above	Average speed, $s=d/t$
Lift to A	7.57 s	7.64 s	7.37 s	7.53 s	31.8 m	4.2 m/s
Fall from A to B	3.45 s	3.61 s	3.59 s	3.56 s	31.8 m	8.9m/s





## Free-Fall Rides

### Ride Measurements—Answer Key

When measuring the end of the fall, make sure that you measure the g's before the ride bends away from the vertical.

1. Take the accelerometer on the ride to measure the accelerations (g's) during the ride.
2. Complete column g in the data table below.
3. Indicate with an "X" which of the four locations below have a maximum kinetic energy (KE), maximum potential energy (PE), minimum KE, or minimum PE. There should be only one X in each column. That is, there is only one location (either during the lift, at the top of the ride, during the fall, or the end of the fall) in which there is a maximum KE. Remember, KE is energy of motion and PE is energy of position.

	g	Maximum KE	Maximum PE	Minimum KE	Minimum PE
During the lift	1				
At the top of the ride	1		X	X	
During the fall	0				
End of the fall	0	X			X



## Roller Coasters—Initial Hill Ground Measurements—Answer Key

Find a coaster that has an initial hill that can be measured using the structure estimation method.

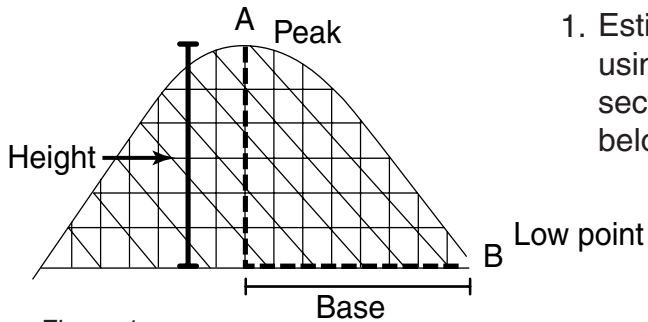

Figure 1.

1. Estimate the height of the first hill from the ground by using the design of the structures. See the Basic Skills section if you have forgotten how to do it. Show your work below.

*If eye level height = 1.4 meters;  
Fractional part = 8/10, then 1.4 meters/(8/10) = 1.75 meters  
(1.75 meters/structure)(6 structures) = 10.5 meters*

2. Find the base length of the first hill by stepping (see fig. 1).

*If base of hill = 32 steps,  
 $32/39 = x/30$  meters  
 $39x = 30 \text{ meters}(32)$   
 $x = 24.6$  meters*

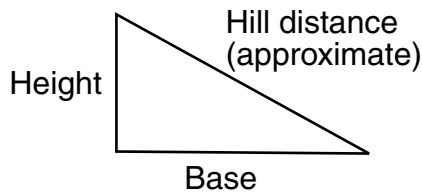

Figure 2.

3. Calculate the approximate hill distance by using the Pythagorean theorem. (Note, this is an approximation of the distance down the first hill because the track is curved at the top and bottom.) Show your work.

$$(\text{base}^2 + \text{height}^2 = \text{hill distance}^2)$$

*$(\text{base})^2 + (\text{height})^2 = (\text{hill distance})^2$   
 $(24.6 \text{ meters})^2 + (10.5 \text{ meters})^2 = (\text{hill distance})^2$   
hill distance = 26.7 meters*

4. Time the roller coaster going down the first hill from point A to point B as shown in figure 1. Do this three times and fill in the data table below.
5. Calculate the average speed of the cars down the first hill. First find the average time of your three trials, and then calculate ( $s = d/t$ ). Fill in data table below.

	Time trial 1	Time trial 2	Time trial 3	Average time	Distance, m	Speed, m/s
From A to B	3.0 s	2.6 s	2.8 s	2.8 s	26.7 m	9.5 m/s



## Roller Coasters—Initial Hill Ride Measurements—Answer Key

Take the accelerometer on the ride, paying close attention to the g measurements.

1. When do microgravity ( $<1$  g) moments occur (up and over a hill, down a hill and into a valley, up a hill, down a hill, over the crest of a hill, going through a valley, around curves)?

*Microgravity conditions occur when moving up and over a hill.*

---

---

2. What was the highest g-level reading you observed? Where was it (up and over a hill, down a hill and into a valley, up a hill, down a hill, over the crest of a hill, going through a valley, around curves)?

*High-g readings will occur while going through a valley and around curves. The values will vary from slightly more than 1 g to up to 4 g.*

---

---



# Bumper Cars

## Ride Measurements—Answer Key

For each collision shown below, circle the appropriate set of arrows to indicate which direction the cars and riders move immediately after impact. Assume the masses of riders A and B are equal.

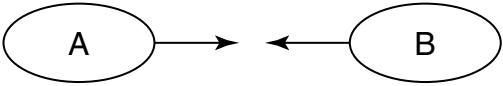
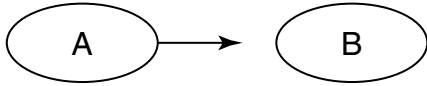
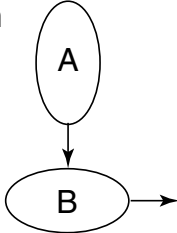
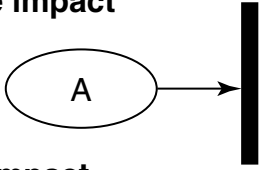
<p><b>1. Head-on collision</b></p> <p><b>Before impact</b></p>  <p><b>After impact</b></p> <table style="width: 100%; border: none;"> <tr> <td style="width: 15%;">Cars:</td> <td style="width: 30%;">A</td> <td style="width: 30%;">B</td> <td style="width: 25%;"></td> </tr> <tr> <td>a.</td> <td>→</td> <td>→</td> <td></td> </tr> <tr> <td>b.</td> <td>←</td> <td>no motion</td> <td></td> </tr> <tr> <td><b>c.</b></td> <td>←</td> <td>→</td> <td></td> </tr> <tr> <td>d.</td> <td>no motion</td> <td>←</td> <td></td> </tr> </table> <table style="width: 100%; border: none;"> <tr> <td style="width: 15%;">Riders:</td> <td style="width: 30%;">A</td> <td style="width: 30%;">B</td> <td style="width: 25%;"></td> </tr> <tr> <td><b>a.</b></td> <td>→</td> <td>←</td> <td></td> </tr> <tr> <td>b.</td> <td>←</td> <td>no motion</td> <td></td> </tr> <tr> <td>c.</td> <td>←</td> <td>→</td> <td></td> </tr> <tr> <td>d.</td> <td>no motion</td> <td>←</td> <td></td> </tr> </table>	Cars:	A	B		a.	→	→		b.	←	no motion		<b>c.</b>	←	→		d.	no motion	←		Riders:	A	B		<b>a.</b>	→	←		b.	←	no motion		c.	←	→		d.	no motion	←		<p><b>2. Rear-end collision</b></p> <p><b>Before impact</b></p>  <p><b>After impact</b></p> <table style="width: 100%; border: none;"> <tr> <td style="width: 15%;">Cars:</td> <td style="width: 30%;">A</td> <td style="width: 30%;">B</td> <td style="width: 25%;">no motion</td> </tr> <tr> <td>a.</td> <td>←</td> <td>no motion</td> <td></td> </tr> <tr> <td><b>b.</b></td> <td>no motion</td> <td>→</td> <td></td> </tr> <tr> <td>c.</td> <td>→</td> <td>→</td> <td></td> </tr> <tr> <td>d.</td> <td>no motion</td> <td>←</td> <td></td> </tr> </table> <table style="width: 100%; border: none;"> <tr> <td style="width: 15%;">Riders:</td> <td style="width: 30%;">A</td> <td style="width: 30%;">B</td> <td style="width: 25%;"></td> </tr> <tr> <td>a.</td> <td>→</td> <td>←</td> <td></td> </tr> <tr> <td><b>b.</b></td> <td>→</td> <td>no motion</td> <td></td> </tr> <tr> <td>c.</td> <td>←</td> <td>→</td> <td></td> </tr> <tr> <td>d.</td> <td>no motion</td> <td>←</td> <td></td> </tr> </table>	Cars:	A	B	no motion	a.	←	no motion		<b>b.</b>	no motion	→		c.	→	→		d.	no motion	←		Riders:	A	B		a.	→	←		<b>b.</b>	→	no motion		c.	←	→		d.	no motion	←	
Cars:	A	B																																																																															
a.	→	→																																																																															
b.	←	no motion																																																																															
<b>c.</b>	←	→																																																																															
d.	no motion	←																																																																															
Riders:	A	B																																																																															
<b>a.</b>	→	←																																																																															
b.	←	no motion																																																																															
c.	←	→																																																																															
d.	no motion	←																																																																															
Cars:	A	B	no motion																																																																														
a.	←	no motion																																																																															
<b>b.</b>	no motion	→																																																																															
c.	→	→																																																																															
d.	no motion	←																																																																															
Riders:	A	B																																																																															
a.	→	←																																																																															
<b>b.</b>	→	no motion																																																																															
c.	←	→																																																																															
d.	no motion	←																																																																															
<p><b>3. Side-impact collision</b></p> <p><b>Before impact</b></p>  <p><b>After impact</b></p> <table style="width: 100%; border: none;"> <tr> <td style="width: 15%;">Cars:</td> <td style="width: 30%;">A</td> <td style="width: 30%;">B</td> <td style="width: 25%;"></td> </tr> <tr> <td>a.</td> <td>↓</td> <td>→</td> <td></td> </tr> <tr> <td><b>b.</b></td> <td>↘</td> <td>↘</td> <td></td> </tr> <tr> <td>c.</td> <td>↙</td> <td>↘</td> <td></td> </tr> <tr> <td>d.</td> <td>no motion</td> <td>↘</td> <td></td> </tr> </table> <table style="width: 100%; border: none;"> <tr> <td style="width: 15%;">Riders:</td> <td style="width: 30%;">A</td> <td style="width: 30%;">B</td> <td style="width: 25%;"></td> </tr> <tr> <td><b>a.</b></td> <td>↓</td> <td>→</td> <td></td> </tr> <tr> <td>b.</td> <td>↘</td> <td>↘</td> <td></td> </tr> <tr> <td>c.</td> <td>↙</td> <td>↘</td> <td></td> </tr> <tr> <td>d.</td> <td>↓</td> <td>↓</td> <td></td> </tr> </table>	Cars:	A	B		a.	↓	→		<b>b.</b>	↘	↘		c.	↙	↘		d.	no motion	↘		Riders:	A	B		<b>a.</b>	↓	→		b.	↘	↘		c.	↙	↘		d.	↓	↓		<p><b>4. Car hits wall</b></p> <p><b>Before impact</b></p>  <p><b>After impact</b></p> <table style="width: 100%; border: none;"> <tr> <td style="width: 15%;">Car:</td> <td style="width: 30%;">A</td> <td style="width: 30%;"></td> <td style="width: 25%;"></td> </tr> <tr> <td>a.</td> <td>→</td> <td></td> <td></td> </tr> <tr> <td><b>b.</b></td> <td>←</td> <td></td> <td></td> </tr> <tr> <td>c.</td> <td>no motion</td> <td></td> <td></td> </tr> </table> <table style="width: 100%; border: none;"> <tr> <td style="width: 15%;">Rider:</td> <td style="width: 30%;">A</td> <td style="width: 30%;"></td> <td style="width: 25%;"></td> </tr> <tr> <td><b>a.</b></td> <td>→</td> <td></td> <td></td> </tr> <tr> <td>b.</td> <td>←</td> <td></td> <td></td> </tr> <tr> <td>c.</td> <td>no motion</td> <td></td> <td></td> </tr> </table>	Car:	A			a.	→			<b>b.</b>	←			c.	no motion			Rider:	A			<b>a.</b>	→			b.	←			c.	no motion										
Cars:	A	B																																																																															
a.	↓	→																																																																															
<b>b.</b>	↘	↘																																																																															
c.	↙	↘																																																																															
d.	no motion	↘																																																																															
Riders:	A	B																																																																															
<b>a.</b>	↓	→																																																																															
b.	↘	↘																																																																															
c.	↙	↘																																																																															
d.	↓	↓																																																																															
Car:	A																																																																																
a.	→																																																																																
<b>b.</b>	←																																																																																
c.	no motion																																																																																
Rider:	A																																																																																
<b>a.</b>	→																																																																																
b.	←																																																																																
c.	no motion																																																																																



## Bumper Cars Ride Measurements—Answer Key

Answer the following questions in complete sentences.

1. During collision 2, is kinetic energy (KE) conserved? Explain why or why not. Yes, KE is conserved. Except for the loss of energy due to heat and sound formed by the collision, the speed and thus the KE of car A was transferred to car B.

---

---

---

2. In collision 3, KE is not conserved. If the total energy of the system is conserved, where did the KE go? Although both cars end up in motion, some KE is lost. The total energy of the system, however, is constant, as some of the KE or energy of motion, is changed to heat and sound. Also, the two cars lock up and combine to be a unit. This unit has a large mass, thus they end up going slower.

3. During collision 4, is KE conserved? Explain why or why not. There will be some loss due to heat and sound, but most of the KE is conserved as the car rebounds from the wall. The harder the surface of the wall, the more KE is conserved.

---

---



## Roller Coasters—Floater Hills Ground Measurements—Answer Key

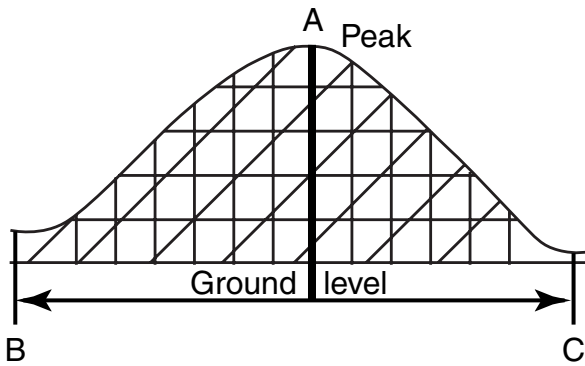

Show your work here.

If eye level height = 1.4 meters,  
fractional part = 4/10, then  
1.4 meters (4/10) = 3.5 meters

$$(30 \text{ meters}/39 \text{ steps})(82 \text{ steps}) = 63 \text{ meters}$$

Locate a medium-sized hill on a coaster ride.

1. Estimate the height of the hill from the ground to the peak (A) by using the design of the structures. See the Basic Skills section if you have forgotten how to do this. Show your work in the box.

$$(30 \text{ meters}/39 \text{ steps})(82 \text{ steps}) = 63 \text{ meters}$$

2. Use stepping to find the hill base distance B to C (low points before and after the hill).

a) Your steps for 30 meters 39

b) Number of steps taken 82

c) Hill base distance (B to C) 63

(Hint: Multiply the number of steps taken by 30 meters and divide this answer by the number of steps you take for 30 meters.)

3. Check the ride information sign by the entrance of the ride to find the total distance of the coaster.

a) Distance in feet 3935

b) Convert your answer to meters 1199

4. Calculate the average speed of the ride. Stand by the start and exit area. Take note of the number or color of the car you will time. Time the ride from when the train of cars leaves the start gate until it returns. Time three cars from start to finish. Be sure to convert the time to seconds. Fill in the table below (answers will vary).

	Car 1	Car 2	Car 3	Average time, s	Total ride distance, m	Average speed, m/s
Total ride	146 s	152 s	144 s	147 s	1199 m	8.16 m/s



## Roller Coasters—Floater Hills Ride Measurements—Answer Key

Take the accelerometer on the ride, paying attention to the g levels. The ride is very fast so it helps if you call out the g measurements to your partner as you go up and down the hills and around the curves.

1. Where did you experience microgravity or low g? Check all that apply.

- around curves
- going up and over the top of the hills
- going down and into a low point or valley

2. What was the lowest g reading? *Answers will vary from values slightly less than 1 g to as low as -1 g.* \_\_\_\_\_

3. Where did you experience high-g levels? Check all that apply.

- around curves
- going up and over the top of the hills
- going down and into a low point or valley

4. What was the highest g reading? *Answers will vary from values greater than 1 to 4 g or more.* \_\_\_\_\_





Measuring the angle of the carousel pole

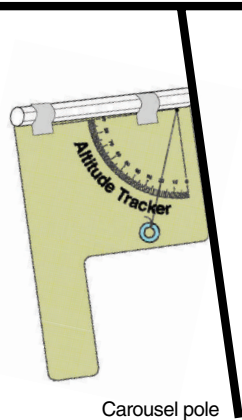

Carousel pole

## Carousels Ground Measurements—Answer Key

Determine the revolutions per minute (rpm) of the carousel.

1. Stand on the ground in front of the carousel and locate a particular spot on the ride. Make sure that you have a way to remember that spot. Position yourself directly in front of it.
2. If the ride is not moving, wait until it begins and has made several turns. When the point that you have selected is directly in front of you, start your stopwatch and keep it running for 5 revolutions.

Total time for 5 revolutions in seconds: 90

4. Calculate the time for 1 revolution. This is called the period of rotation of the ride. Time for 1 revolution (period of rotation): 90 seconds/5 revolutions = 18 seconds/revolution

5. To find the revolutions per minute of the ride, divide 60 by the period of rotation, since there are 60 seconds in 1 minute. Revolutions per minute:

(60 seconds/minute)/(18 seconds/1 revolution) = 3.33 rpm

## Carousels Ride Measurements

1. There is a “lean” of the benches and on the poles that support the animals. When the ride is stationary, use your altitude tracker to determine the angle that an animal in the outer row makes with the vertical. While holding the tracker vertically, place it against the animal’s support pole, reading the angle between the center of the pole and the zero mark on the tracker. Angle = 8°

2. Measure the angle that an animal in the inner row makes with the vertical. Angle = 3°

3. Which animal has a larger angle, the one located in the inner row or the one in the outer row?  
Outer row

4. Do the same measurements on the very same animals while the ride is in motion.  
Inner angle: 0° Outer angle: 0°

5. How do the results of angle measurements compare when looking at stationary ride animals versus moving ride animals? Explain your answer. The motion of the ride (circular path) creates a centripetal force acting on the horses and the riders. The horses are angled inward, which is similar to banking a road around curves. Thus, the rider is able to stay on the horse easier.





## Roller Coasters—Loops Ground Measurements—Answer Key

The loops of a roller coaster are not circles; they are called clothoid loops. Circular loops require a higher amount of speed to keep the riders from falling out when they are upside down. Roller coasters use clothoid loops, which have a smaller radius at the top of the loop, and a longer radius where the cars enter and exit the loop (see fig. 1).

Why do you think roller coasters use clothoid loops instead of circular loops? The smaller radius at the top of the ride allows for slower speeds, while still maintaining a curved path, preventing the car and riders from falling off the track.

## Roller Coasters—Loops Ride Measurements

- When riding in a loop at high speeds, pay close attention to whether you feel heavier, lighter, or normal in your seat. Refer to figure 2 to assist you when completing the following table (select one per row).

Location of ride	Heavier	Lighter	Normal
Going into loop (A)	x		
At top of loop (B)	x*	x*	x*
Going out of loop (C)	x		

- A rider experiences a different sensation when sitting in the front than sitting in the back. First, ride the coaster seated in a front car. Secondly, ride the coaster again seated in a back car. Finally, try sitting in the middle of the coaster. In which seat location did you experience faster speeds at the top of the loop?

One would experience faster speeds when seated in the back.

- If you had a hat on your head while riding and your hat fell off as the coaster car approached the top of the loop, which way would it go, ignoring air resistance? (Caution: Do not actually try this on the ride!)

- Draw the path of the hat by drawing an arrow on figure 2.
- Which of Newton's laws applies to the hat when it leaves your head. State the complete law below.

Newton's first law of motion: A body in motion continues in motion, in a straight line, unless acted on by an external net force.



Figure 1.

\*Note, depending on the rider's speed at the top of loop, all three choices here would be correct.

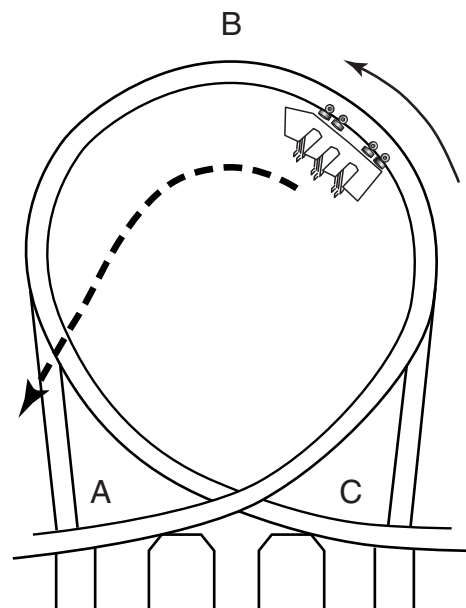

Figure 2. The dashed line is a parabolic curve.



## Pendulum Rides Ground Measurements—Answer Key

Stand facing the ride, lined up with the center of the pendulum. See point B in the figure below.

1. Estimate the height of point A using the “scale drawing method.” Show your work, including the diagram.

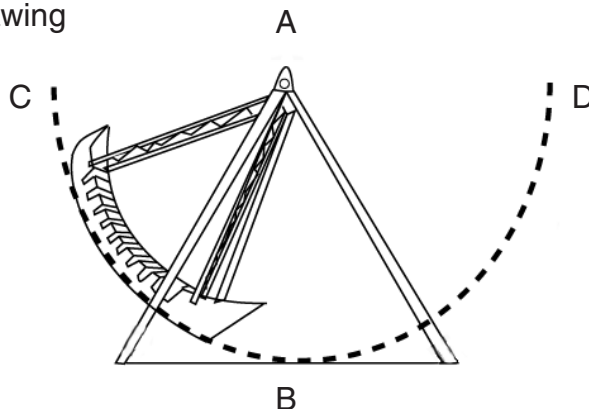
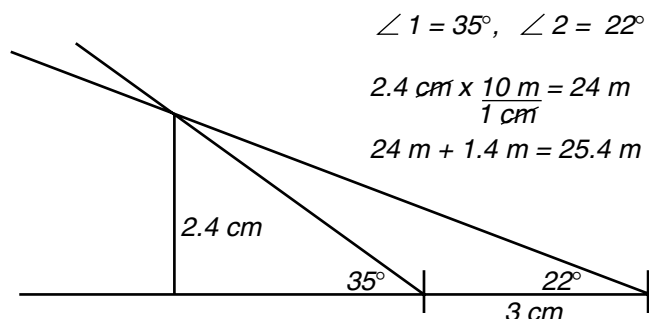

2. To determine the radius of the pendulum ride, find the distance that point B is above the ground. Subtract this number from the answer found in number 1 above. Show your work.

$$25.4 \text{ meters} - 1.6 \text{ meters} = 23.8 \text{ meters}$$

3. The time of a simple pendulum’s swing can be expressed as  $t = 2\pi\sqrt{\frac{l}{g}}$ , where  $t$  = time for one full swing in second (period),  $l$  = length of pendulum’s radius,  $\pi \approx 3.14$ ,  $g = 9.8 \text{ meters/second}^2$ . Calculate the expected time for one full swing (from C to D to C) for the ride. Show your work.

$$t = 2 \times \pi \sqrt{\frac{23.8 \text{ meters}}{9.8 \text{ meters/second}^2}}, \text{ then } t = 9.8 \text{ seconds}$$

4. Wait until the ride reaches the top of the swing (point C or D) then begin counting the number of swings, or vibrations (C–D–C) that occur in 30 seconds. Estimate any fractional portions of the swing. Do three trials and calculate an average. Fill in the table below.

	Trial 1	Trial 2	Trial 3	Average
Number of swings/ vibrations in 30 seconds	3.8	3.7	3.9	3.8

5. Calculate the average time for a swing/vibration by dividing 30 seconds by the average number of swings. The average number of swings was found in number 4 above.

$$30 \text{ seconds} / 3.8 \text{ vibrations} = 7.9 \text{ seconds/vibration}$$

6. Explain why the pendulum ride is not actually a true pendulum that falls due to gravity.

The time for a true pendulum with the given radius is 10.4 seconds, while the pendulum ride was only 7.9 seconds.  
There are motors and other machinery that control the speed of the ride.



# Pendulum Rides

## Ride Measurements—Answer Key

1. Take the accelerometer on the ride. Label figure 1 where you experienced
  - a. The highest g, lowest g, and 1 g
  - b. Your weight to be normal, heavier, or lighter

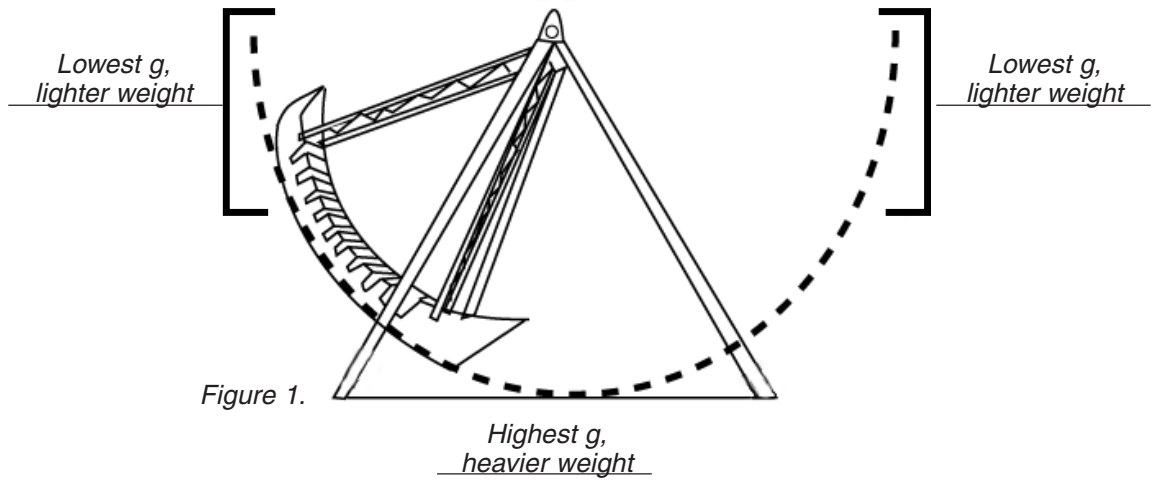

2. A daring rider wants to experience the greatest range of g loads. Draw two arrows in figure 2 to indicate where he or she should sit. Hint: Consider working with another group or two, each sitting in different rows. Compare which rows give the highest and lowest accelerometer readings.

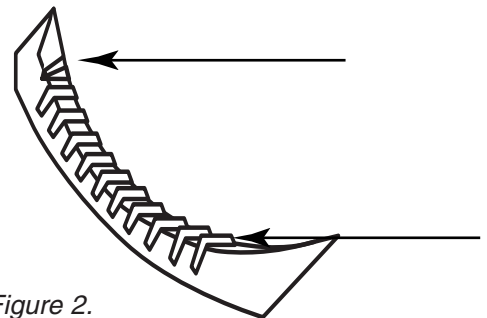

3. The KC-135 flies in a parabolic path, similar to the pendulum ride. Draw the entire path of two KC-135 parabolas in the box below. Circle the portion that is similar to the path of the pendulum ride.

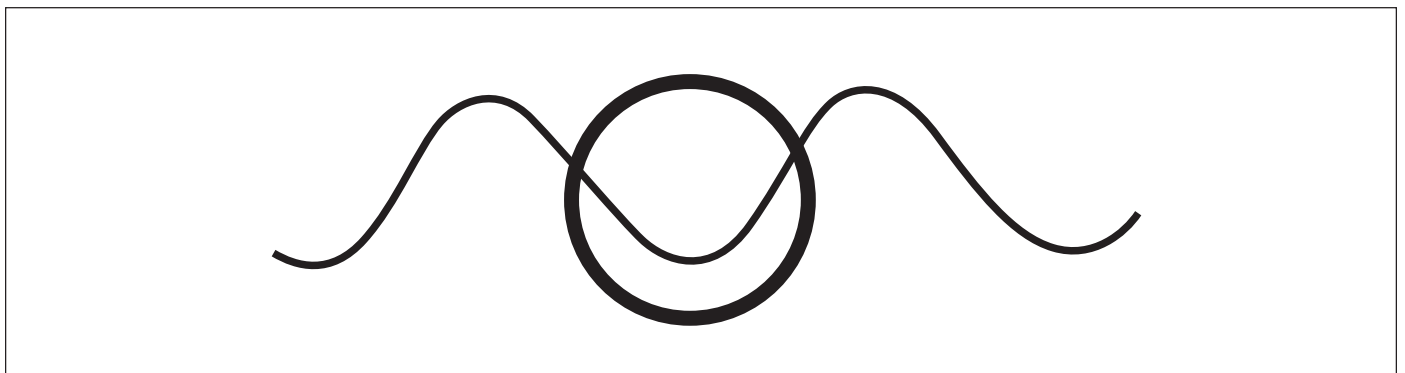



# Tests





## Pretest

### Amusement Park Physics With a NASA Twist

1. \_\_\_\_\_ True or False. Astronauts experience weightlessness because they are high enough where the Earth's gravity is extremely low, as in microgravity.
2. \_\_\_\_\_ True or False. There are microgravity research facilities at NASA where scientists drop their experiments to eliminate some of the effects of gravity.
3. \_\_\_\_\_ True or False. In the loop rides, where the riders experience circular motion, they also experience high gravity conditions.
4. \_\_\_\_\_ Newton's first law of motion is when objects tend to move in a straight line at a constant \_\_\_\_\_, unless acted upon by an outside force.  
A. acceleration      B. temperature      C. speed      D. speed and acceleration
5. \_\_\_\_\_ True or False. The horses located on the outer part of a carousel travel at a different speed than the horses located in the inner part.
6. \_\_\_\_\_ Given a normal walking stride, which value most nearly applies to pacing a distance of 30 meters.  
A. 11 to 15 steps      B. 18 to 25 steps      C. 40 to 60 steps      D. 100 to 110 steps
7. Place an "X" on the lines next to all the locations on a roller coaster hill where the rider might experience high-g loads while traveling at high speeds.  
\_\_\_\_\_ at the top of a hill      \_\_\_\_\_ at the bottom of a hill      \_\_\_\_\_ going around a curve
8. Place an "X" on the lines next to all that are correct. A pendulum that moves freely back and forth will move faster if  
\_\_\_\_\_ the string that supports it is shortened  
\_\_\_\_\_ the string that supports it is lengthened  
\_\_\_\_\_ the mass or bob at the end of the string is made heavier  
\_\_\_\_\_ the mass or bob at the end of the string is made lighter  
\_\_\_\_\_ the pendulum is moved to the International Space Station  
\_\_\_\_\_ the pendulum is moved inside a deep mine shaft that is closer to the center of Earth
9. \_\_\_\_\_ True or False. When two identical marbles collide head-on and each marble rebounds at the same speed that it was initially traveling, we can say that momentum was conserved in the collision, but kinetic energy was not.
10. \_\_\_\_\_ True or False. In order for the roller coaster to take full advantage of the physical properties of the ride design, the first hill must be the highest hill.



## Pretest Answer Key

### Amusement Park Physics With a NASA Twist

1. F True or False. Astronauts experience weightlessness because they are high enough where the Earth's gravity is extremely low, as in microgravity.
2. T True or False. There are microgravity research facilities at NASA where scientists drop their experiments to eliminate some of the effects of gravity.
3. T True or False. In the loop rides, where the riders experience circular motion, they also experience high gravity conditions.
4. C Newton's first law of motion is when objects tend to move in a straight line at a constant \_\_\_\_\_, unless acted upon by an outside force.  
A. acceleration      B. temperature      C. speed      D. speed and acceleration
5. T True or False. The horses located on the outer part of a carousel travel at a different speed than the horses located in the inner part.
6. C Given a normal walking stride, which value most nearly applies to pacing a distance of 30 meters.  
A. 11 to 15 steps      B. 18 to 25 steps      C. 40 to 60 steps      D. 100 to 110 steps
7. Place an "X" on the lines next to all the locations on a roller coaster hill where the rider might experience high-g loads while traveling at high speeds.  
\_\_\_\_\_ at the top of a hill    X at the bottom of a hill    X \_\_\_\_\_ going around a curve
8. Place an "X" on the lines next to all that are correct. A pendulum that moves freely back and forth will move faster if  
X \_\_\_\_\_ the string that supports it is shortened  
\_\_\_\_\_ the string that supports it is lengthened  
\_\_\_\_\_ the mass or bob at the end of the string is made heavier  
\_\_\_\_\_ the mass or bob at the end of the string is made lighter  
\_\_\_\_\_ the pendulum is moved to the International Space Station  
\_\_\_\_\_ the pendulum is moved inside a deep mine shaft that is closer to the center of Earth
9. F True or False. When two identical marbles collide head-on and each marble rebounds at the same speed that it was initially traveling, we can say that momentum was conserved in the collision, but kinetic energy was not.
10. T True or False. In order for the roller coaster to take full advantage of the physical properties of the ride design, the first hill must be the highest hill.





## Post Test

### Amusement Park Physics With a NASA Twist

1. \_\_\_\_\_ True or False. Astronauts experience weightlessness because they are high enough where the Earth's gravity is extremely low, as in microgravity.
2. \_\_\_\_\_ True or False. There are microgravity research facilities at NASA where scientists drop their experiments to eliminate some of the effects of gravity.
3. \_\_\_\_\_ True or False. In the loop rides, where the riders experience circular motion, they also experience high gravity conditions.
4. \_\_\_\_\_ Newton's first law of motion is when objects tend to move in a straight line at a constant \_\_\_\_\_, unless acted upon by an outside force.  
A. acceleration      B. temperature      C. speed      D. speed and acceleration
5. \_\_\_\_\_ True or False. The horses located on the outer part of a carousel travel at a different speed than the horses located in the inner part.
6. \_\_\_\_\_ Given a normal walking stride, which value most nearly applies to pacing a distance of 30 meters.  
A. 11 to 15 steps      B. 18 to 25 steps      C. 40 to 60 steps      D. 100 to 110 steps
7. Place an "X" on the lines next to all the locations on a roller coaster hill where the rider might experience high-g loads while traveling at high speeds.  
\_\_\_\_\_ at the top of a hill      \_\_\_\_\_ at the bottom of a hill      \_\_\_\_\_ going around a curve
8. Place an "X" on the lines next to all that are correct. A pendulum that moves freely back and forth will move faster if  
\_\_\_\_\_ the string that supports it is shortened  
\_\_\_\_\_ the string that supports it is lengthened  
\_\_\_\_\_ the mass or bob at the end of the string is made heavier  
\_\_\_\_\_ the mass or bob at the end of the string is made lighter  
\_\_\_\_\_ the pendulum is moved to the International Space Station  
\_\_\_\_\_ the pendulum is moved inside a deep mine shaft that is closer to the center of Earth
9. \_\_\_\_\_ True or False. When two identical marbles collide head-on and each marble rebounds at the same speed that it was initially traveling, we can say that momentum was conserved in the collision, but kinetic energy was not.
10. \_\_\_\_\_ True or False. In order for the roller coaster to take full advantage of the physical properties of the ride design, the first hill must be the highest hill.



## Post Test Answer Key

### Amusement Park Physics With a NASA Twist

1. F True or False. Astronauts experience weightlessness because they are high enough where the Earth's gravity is extremely low, as in microgravity.
2. T True or False. There are microgravity research facilities at NASA where scientists drop their experiments to eliminate some of the effects of gravity.
3. T True or False. In the loop rides, where the riders experience circular motion, they also experience high gravity conditions.
4. C Newton's first law of motion is when objects tend to move in a straight line at a constant \_\_\_\_\_, unless acted upon by an outside force.  
A. acceleration    B. temperature    C. speed    D. speed and acceleration
5. T True or False. The horses located on the outer part of a carousel travel at a different speed than the horses located in the inner part.
6. C Given a normal walking stride, which value most nearly applies to pacing a distance of 30 meters.  
A. 11 to 15 steps    B. 18 to 25 steps    C. 40 to 60 steps    D. 100 to 110 steps
7. Place an "X" on the lines next to all the locations on a roller coaster hill where the rider might experience high-g loads while traveling at high speeds.  
\_\_\_\_\_ at the top of a hill    X at the bottom of a hill    X going around a curve
8. Place an "X" on the lines next to all that are correct. A pendulum that moves freely back and forth will move faster if  
X the string that supports it is shortened  
\_\_\_\_\_ the string that supports it is lengthened  
\_\_\_\_\_ the mass or bob at the end of the string is made heavier  
\_\_\_\_\_ the mass or bob at the end of the string is made lighter  
\_\_\_\_\_ the pendulum is moved to the International Space Station  
\_\_\_\_\_ the pendulum is moved inside a deep mine shaft that is closer to the center of Earth
9. F True or False. When two identical marbles collide head-on and each marble rebounds at the same speed that it was initially traveling, we can say that momentum was conserved in the collision, but kinetic energy was not.
10. T True or False. In order for the roller coaster to take full advantage of the physical properties of the ride design, the first hill must be the highest hill.



# Forms and Extras





# Amusement Park Physics Day Announcement and Contract

Where: \_\_\_\_\_  
When: \_\_\_\_\_  
Who: \_\_\_\_\_  
Time: Leave school: \_\_\_\_\_ Arrive at park: \_\_\_\_\_  
Leave park: \_\_\_\_\_ Arrive at school: \_\_\_\_\_  
Cost: \_\_\_\_\_

## What is NASA Amusement Park Physics Day?

- Amusement parks are exceptional places to study forces and motion firsthand. On and off the rides, students can experience the same moments of high gravity and microgravity that astronauts encounter. In addition to having fun, students can do scientific research, take measurements, and collect data about forces they encounter on the rides.
- NASA Amusement Park Physics Day is a culminating event of an integrated science and mathematics unit that centers on topics of energy, motion, force, gravity, and the NASA microgravity connection. Students prepare for several weeks learning the physics involved in amusement park rides and practicing how to estimate heights, speeds, and accelerations.
- Students will work together in groups at the park. Riders and nonriders alike will spend half of a day taking measurements on the ground and on the rides to complete worksheets. A teacher will be stationed at each ride so students can check in as a complete team and receive any needed assistance. The completed workbook is due at midday.
- After the assignment is turned in to the staff, the students will be free to enjoy the park at their leisure for the rest of the day.

## Student Selection

Participation in this field trip is a privilege that must be earned. The following criteria will be used to select participants:

- Grades—passing all classes, displaying honest effort
- Attendance—on time, present (Tardiness and absence will be considered.)
- Behavior—respectful, responsible (Referrals to the office for inappropriate behavior will be reviewed on a case-by-case basis. Any student receiving a school suspension is ineligible.)

.....

I have read and understand the above information concerning Physics Day. I realize that my performance in the classroom as well as my attendance and behavior will directly affect my chances at being selected to attend the trip.

Student Signature: \_\_\_\_\_ Date: \_\_\_\_\_

Parent Signature: \_\_\_\_\_ Date: \_\_\_\_\_



# Amusement Park Physics Day Announcement and Contract

## Permission

To be completed by parent or guardian:

I hereby give my permission for my son/daughter, \_\_\_\_\_, to go to  
\_\_\_\_\_ on \_\_\_\_\_

Transportation \_\_\_\_\_ Cost \_\_\_\_\_

Parent/Guardian Signature \_\_\_\_\_ Date \_\_\_\_\_

## Emergency Information

In the event that reasonable attempts to contact me at \_\_\_\_\_-\_\_\_\_\_-\_\_\_\_\_ (day phone) or  
\_\_\_\_\_-\_\_\_\_\_-\_\_\_\_\_ (emergency number) have been unsuccessful, I hereby give my consent for

1. The administration of any treatment deemed necessary by Dr. \_\_\_\_\_  
(preferred physician) at \_\_\_\_\_-\_\_\_\_\_-\_\_\_\_\_ (phone number of doctor), or in the event  
that a designated preferred practitioner is not available, treatment may be administered by  
another licensed physician or dentist.
2. The transfer of the child to \_\_\_\_\_ (preferred hospital) or any  
hospital reasonably accessible.

Allergies \_\_\_\_\_

Other health-related issues \_\_\_\_\_

.....

## Refusal of Consent

I do **not** give my consent for emergency medical treatment of my child. In the event of illness or  
injury requiring emergency treatment, I wish the school authorities to contact

Name: \_\_\_\_\_ Phone: \_\_\_\_\_

Address: \_\_\_\_\_

Signature: \_\_\_\_\_ Date: \_\_\_\_\_



# Amusement Park Physics Day Ride Station Rotation Chart

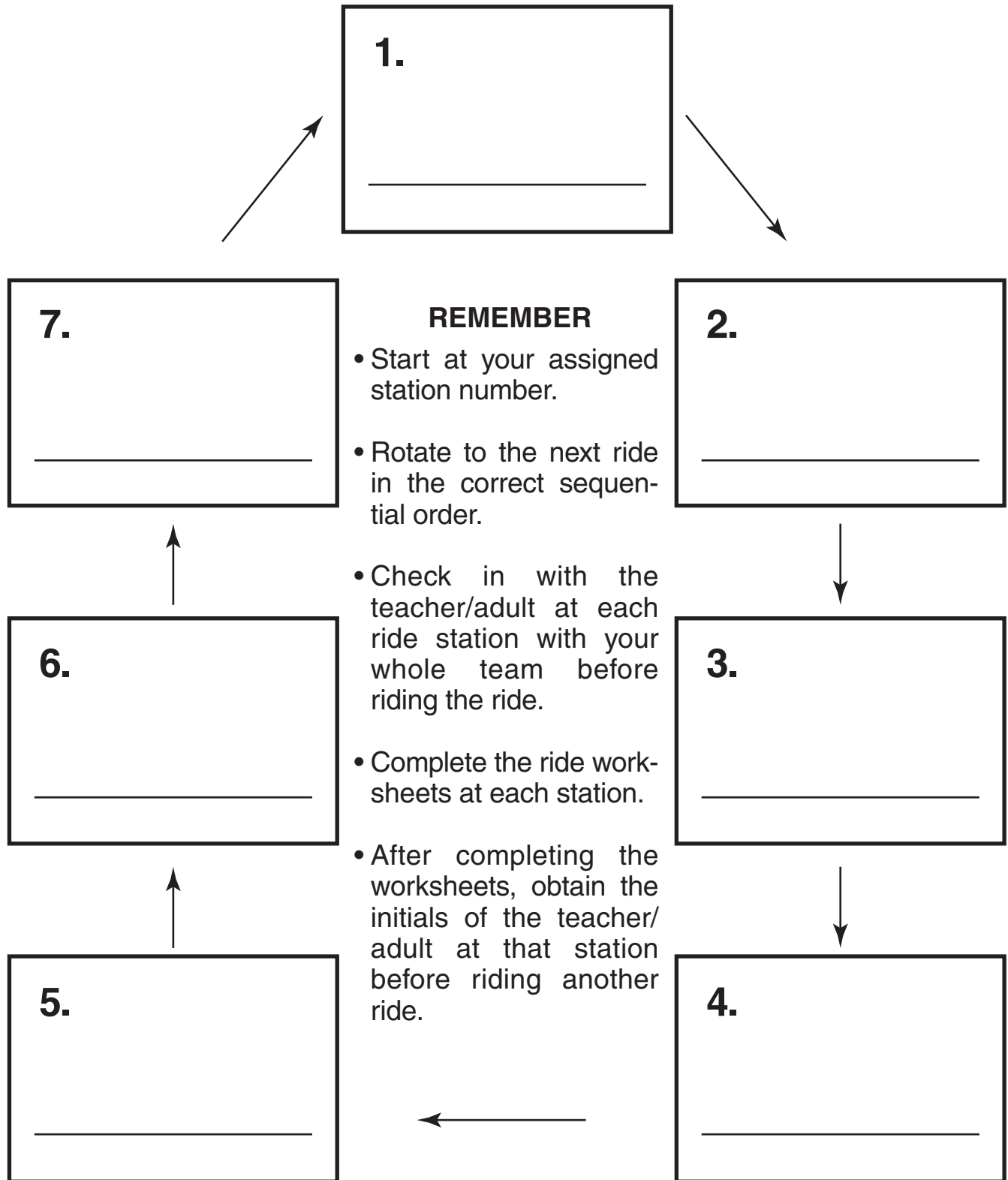

## Amusement Park Physics Day Eye Level Height and Stepping Estimation Record

Name	Eye level height	10 meters = ____ steps	30 meters = ____ steps
1.			
2.			
3.			
4.			
5.			
6.			
7.			
8.			
9.			
10.			
11.			
12.			
13.			
14.			
15.			
16.			
17.			
18.			
19.			
20.			
21.			
22.			
23.			
24.			
25.			
26.			
27.			
28.			
29.			
30.			





# Amusement Park Physics Day Classroom Master Materials List

## Basic Skills

### Time

- Stopwatch

### Distance

- Meter stick
- Masking tape

### Eye Level Height

- Meter stick
- Masking tape
- Ruler for sighting along

### Altitude Tracker

- Cardboard or file folders (6 by 8 inches)
- Altitude Tracker templates
- 6-inch dental floss
- One washer
- One straw
- Glue
- Scissors
- Clear tape
- Push pin

### Altitude Estimation Methods

- Altitude Tracker
- Ruler
- Pencil
- Protractor
- Calculator (optional)

### Accelerometer

- Plastic thermometer tube
- Rubber band (large)
- Two end caps
- Two masses or fishing sinkers (1.5 ounces)
- Spring
- Red tape (1/8 inch)
- Paper clip
- Two pieces of duct tape (1/2 inch)
- Push pin
- String (12 inch)
- Scissors
- Pliers
- Permanent marker

## Classroom Activities (per group)

### Pendulums—Part 1

- Stopwatch
- 1-meter-long string
- One washer
- Meter stick
- Tape
- Paper clip
- Ring or support stand
- C-clamp

### Pendulums—Part 2

- Stopwatch
- 60-centimeter-long string
- 10 washers or masses
- Meter stick
- Tape
- Film canister
- Ring or support stand
- C-clamp
- Velcro®

### Collisions—Part 1

- Plastic ruler with center groove (30 centimeters long) or similar items for tracking marbles, such as ornate wooden molding
- Eight identical marbles

### Collisions—Part 2

- Two plastic rulers with center groove (30 centimeters long) or similar items for tracking marbles, such as ornate wooden molding
- Two identical books or boards to use as ramp supports (5 centimeters high)
- Two identical marbles

### Marble Run—Part 1

- Three half pieces of copper pipe insulation (18 feet in length)
- Masking tape
- Meter stick
- Stopwatch
- One marble

### Marble Run—Part 2

- Three half pieces of copper pipe insulation (18 feet in length)
- Masking tape
- Meter stick
- Stopwatch
- One marble
- Digital camera (optional)

### Marble Run—Part 3

- Two half pieces of copper pipe insulation (12 feet in length)
- Masking tape
- Meter stick
- Stopwatch
- One marble

### Marble Run—Part 4

- Two half pieces of copper pipe insulation (12 feet in length)
- Masking tape
- Meter stick
- Stopwatch
- One marble



# Amusement Park Physics Day

## Amusement Park Day Master Materials List

### Ride Worksheets

#### Teacher Supplies (one per student group)

- Plastic resealable-top bag (gallon size)
- Altitude Tracker
- Accelerometer
- Protractor
- Ride worksheets and answer key

#### Student Supplies (at least one per group)

- Pencil
- Stopwatch or watch with a second hand
- Calculator
- Metric ruler
- Clipboard (optional, but very helpful)
- Backpack (optional)

### Other Materials to Consider

- Extra student ride packets
- Lunch money or a bagged lunch
- Change of clothes
- Sunscreen/hat/sunglasses
- Raincoat/poncho/umbrella (inclement weather)
- Camera and film
- Comfortable walking shoes/socks
- Layered clothing (Students should be prepared for inclement weather.)
- Wristwatch (Students need to be aware of the time throughout the day.)



## Amusement Park Physics Day Bus List

Bus number \_\_\_\_\_

Name		Name	
1.		26.	
2.		27.	
3.		28.	
4.		29.	
5.		30.	
6.		31.	
7.		32.	
8.		33.	
9.		34.	
10.		35.	
11.		36.	
12.		37.	
13.		38.	
14.		39.	
15.		40.	
16.		41.	
17.		42.	
18.		43.	
19.		44.	
20.		45.	
21.		46.	
22.		47.	
23.		48.	
24.		49.	
25.		50.	



## Amusement Park Physics Day Ride Attendance Form

Team # \_\_\_\_\_ Starting station # \_\_\_\_\_

Name	Present at station
1.	
2.	
3.	
4.	

This ride worksheet is complete. \_\_\_\_\_ (Initials)

Team # \_\_\_\_\_ Starting station # \_\_\_\_\_

Name	Present at station
1.	
2.	
3.	
4.	

This ride worksheet is complete. \_\_\_\_\_ (Initials)

Team # \_\_\_\_\_ Starting station # \_\_\_\_\_

Name	Present at station
1.	
2.	
3.	
4.	

This ride worksheet is complete. \_\_\_\_\_ (Initials)

Team # \_\_\_\_\_ Starting station # \_\_\_\_\_

Name	Present at station
1.	
2.	
3.	
4.	

This ride worksheet is complete. \_\_\_\_\_ (Initials)

Team # \_\_\_\_\_ Starting station # \_\_\_\_\_

Name	Present at station
1.	
2.	
3.	
4.	

This ride worksheet is complete. \_\_\_\_\_ (Initials)

Team # \_\_\_\_\_ Starting station # \_\_\_\_\_

Name	Present at station
1.	
2.	
3.	
4.	

This ride worksheet is complete. \_\_\_\_\_ (Initials)

Team # \_\_\_\_\_ Starting station # \_\_\_\_\_

Name	Present at station
1.	
2.	
3.	
4.	

This ride worksheet is complete. \_\_\_\_\_ (Initials)

Team # \_\_\_\_\_ Starting station # \_\_\_\_\_

Name	Present at station
1.	
2.	
3.	
4.	

This ride worksheet is complete. \_\_\_\_\_ (Initials)



# Resources





# Vocabulary

**acceleration**—the rate of change of velocity

**displacement**—change in position of an object

**force**—a push or a pull exerted on some object

**frame of reference**—a coordinate system for specifying the precise location of objects in space

**free fall**—the state of moving and being acted upon only by the force of gravity

**g**—describes the level of gravity at sea level, for example, 1 g

**gravity**—the acceleration caused by the attractive force between two objects that is proportional to their masses; generally, it is taken to be the acceleration of an object to Earth

**high g**—conditions or environments that create the sensation of an increase of gravitational effects, greater than 1 g

**kinetic energy**—energy associated with an object in motion

**law of universal gravitation**—the force of gravitational pull between any two objects is directly related to their masses and inversely related to the square of their distance

**low g**—conditions or environments that create sensation of a reduction of gravitational effects, less than 1 g

**mass**—the measure of an object's inertia

**microgravity**—an environment in which some of the effects of gravity are minimized

**Newton's first law of motion**—an object continues in a state of rest or uniform motion unless an unbalanced force acts on it

**Newton's second law of motion**—the acceleration of an object is directly proportional to the force acting on the object, is inversely proportional to the mass of the object, and is in the same direction as the force

**Newton's third law of motion**—for every force or action, there is an equal and opposite force or reaction

**period**—the time in seconds for one complete vibration, cycle, or oscillation

**potential energy**—a stored form of energy associated with an object due to its position relative to Earth or some other gravitational source

**speed**—the rate of change of distance

**structure estimation**—use of the regularity of support structures to estimate the height of the entire structure

**velocity**—the rate of change of displacement

**vibration**—one complete cycle or complete path



## List of Formulas

$$a = (v_f - v_i)/(t_f - t_i)$$

Acceleration is the rate of change of velocity

$$\text{displacement} = v_f - v_i$$

Change in position

$$F = ma$$

Force is equal to the product of the object's mass times the acceleration  
(Newton's second law of motion)

$$KE = 1/2 mv^2$$

Kinetic energy is equal to one-half the product of the mass times the velocity squared

$$PE = mgh$$

Potential energy is equal to the product of the mass, the gravity, and the height

$$\text{Height of support structure} = (\text{eye level height})/(\text{span fraction})$$

$$\text{momentum} = mv$$

Momentum is equal to the product of the mass and velocity

$$s = d/t$$

Speed is equal to the change in distance divided by the change in time

$$t = 2\pi\sqrt{l/g}$$

The time (period) for one vibration of a pendulum is equal to  $2\pi$  times the square root of the length divided by gravity

$$\text{velocity}_{\text{ave}} = (x_f - x_i)/(t_f - t_i)$$

The average velocity is equal to the total displacement divided by the change in time





## Amusement Park Physics and Related Web Sites

### Amusement Park Physics

<http://curie.uncg.edu/~mturner/title.html>

This site has several activities with questions that can be used while riding on several well-known amusement park rides. The answers are given as well.

### Amusement Park Physics: What are the forces behind the fun?

<http://www.learner.org/exhibits/parkphysics/>

This excellent Web site has lesson plans, creative demonstrations, roller coaster FAQs, information on Newton's laws of motion, and concise explanations on aerodynamics.

### Coaster Links: Build a Coaster

<http://dsc.discovery.com/convergence/coasters/interactive/interactive.html>

Design a roller coaster and find out how it rates on the "fearometer."

### Funderstanding: Roller Coasters

<http://www.funderstanding.com/k12/coaster/>

Students design their own thrilling roller coaster rides while applying physics concepts.

### Physics of Amusement Parks

<http://library.thinkquest.org/2745/data/openpark.htm>

Students learn about potential and kinetic energy, centripetal force, and free fall. This site offers information and statistics on major roller coasters. Directions are provided on how to build an accelerometer.

### Roller Coaster Database

<http://www.rcdb.com/>

This site provides the most complete and accurate statistics on more than 475 roller coasters found throughout the world.

### Amusement Park Physics Links

<http://homepage.mac.com/cbakken/pga/links.html>

This site has links to other interesting sites, including one that simulates the forces in a Clothoid loop.

### Avian Development Facility

[http://spaceresearch.nasa.gov/research\\_projects/ros/adfop.html](http://spaceresearch.nasa.gov/research_projects/ros/adfop.html)

This site describes flight hardware that studies the development of bird embryos in low gravity.

### Drop Towers

<http://microgravity.grc.nasa.gov/drop2/>

<http://microgravity.grc.nasa.gov/FACILITY/ZERO.HTM>

These Web sites describe two facilities and the scientific research done at NASA Glenn Research Center where weightlessness is created using free fall.

### Research Aircraft (KC-135)

<http://jsc-aircraft-ops.jsc.nasa.gov/kc135/index.html>

Find out about how NASA research aircraft create weightless conditions.

### Sounding Rockets

<http://www.wff.nasa.gov/pages/soundingrockets.html>

Discover information about research rockets used to create weightless conditions.



## NASA Resources for Educators

**Central Operation of Resources for Educators (CORE)** was established for the national and international distribution of NASA-produced educational materials in multimedia format. Educators can obtain a catalogue and an order form by one of the following methods:

NASA CORE  
Lorain County Joint Vocational School  
15181 Route 58 South  
Oberlin, OH 44074-9799  
Phone: 440-775-1400  
Fax: 440-775-1460  
E-mail: [nasaco@leeca.org](mailto:nasaco@leeca.org)  
Home page: <http://core.nasa.gov>

### **Educator Resource Center Network (ERCN)**

To make additional information available to the education community, NASA has created the NASA ERCN. Educators may preview, copy, or receive NASA materials at these sites. Phone calls are welcome if you are unable to visit the ERC (Educator Resource Center) that serves your geographic area. A list of the centers and the regions they serve includes

*AK, Northern CA, HI, ID, MT, NV, OR, UT, WA, WY*

NASA Educator Resource Center

#### **NASA Ames Research Center**

Mail Stop 253-2

Moffett Field, CA 94035-1000

Phone: 650-604-3574

<http://amesnews.arc.nasa.gov/erc/erchome.html>

*IL, IN, MI, MN, OH, WI*

NASA Educator Resource Center

#### **NASA Glenn Research Center**

Mail Stop 8-1

21000 Brookpark Road

Cleveland, OH 44135

Phone: 216-433-2017

<http://www.grc.nasa.gov/WWW/PAO/html/edteachr.htm>

*CT, DE, DC, ME, MD, MA, NH, NJ, NY, PA, RI, VT*

NASA Educator Resource Laboratory

#### **NASA Goddard Space Flight Center**

Mail Code 130.3

Greenbelt, MD 20771-0001

Phone: 301-286-8570

<http://www.gsfc.nasa.gov/vc/erc.htm>



*CO, KS, NE, NM, ND, OK, SD, TX*  
Space Center Houston  
NASA Educator Resource Center  
**NASA Johnson Space Center**  
1601 NASA Road One  
Houston, TX 77058  
Phone: 281-244-2129  
[http://www.spacecenter.org/educator\\_resource.html](http://www.spacecenter.org/educator_resource.html)

*FL, GA, PR, VI*  
NASA Educator Resource Center  
**NASA Kennedy Space Center**  
Mail Code ERC  
Kennedy Space Center, FL 32899  
Phone: 321-867-4090  
<http://www-pao.ksc.nasa.gov/kscpao/educate/edu.htm>

*KY, NC, SC, VA, WV*  
Virginia Air & Space Center  
NASA Educator Resource Center  
**NASA Langley Research Center**  
600 Settlers Landing Road  
Hampton, VA 23669-4033  
Phone: 757-727-0900 x757  
<http://www.vasc.org/erc/>

*AL, AR, IA, LA, MO, TN*  
U.S. Space and Rocket Center  
NASA Educator Resource Center  
**NASA Marshall Space Flight Center**  
One Tranquility Base  
Huntsville, AL 35807  
Phone: 256-544-5812  
<http://erc.msfc.nasa.gov>

*MS*  
NASA Educator Resource Center  
**NASA Stennis Space Center**  
Mail Stop 1200  
Stennis Space Center, MS 39529-6000  
Phone: 228-688-3338  
<http://education.ssc.nasa.gov/erc/erc.htm>



CA  
NASA Educator Resource Center  
**NASA Jet Propulsion Laboratory**  
Village at Indian Hill  
1460 East Holt Avenue, Suite 20  
Pomona, CA 91767  
Phone: 909-397-4420  
[http://learn.jpl.nasa.gov/resources/resources\\_index.html](http://learn.jpl.nasa.gov/resources/resources_index.html)

*AZ and Southern CA*  
NASA Educator Resource Center  
**NASA Dryden Flight Research Center**  
PO Box 273 M/S 4839  
Edwards, CA 93523-0273  
Phone: 661-276-5009  
<http://www.dfrc.nasa.gov/trc/ERC/>

*VA and MD's Eastern Shores*  
NASA Educator Resource Center  
**GSFC/Wallops Flight Facility**  
Visitor Center Building J-17  
Wallops Island, VA 23337  
Phone: 757-824-2298  
<http://www.wff.nasa.gov/~WVC/ERC.htm>

**Regional Educator Resource Centers** offer more educators access to NASA educational materials. NASA has formed partnerships with universities, museums, and other educational institutions to serve as regional ERCs in many states. A complete list of regional ERCs is available through CORE, or electronically via NASA Spacelink at <http://spacelink.nasa.gov/ern>.

**NASA's Education Home Page** serves as the education portal for information regarding educational programs and services offered by NASA for the American education community. This high-level directory of information provides specific details and points of contact for all of NASA's educational efforts, field center offices, and points of presence within each state. Visit this resource at the following address: <http://education.nasa.gov>.

**NASA Spacelink** is one of NASA's electronic resources specifically developed for the educational community. Spacelink serves as an electronic library to NASA's educational and scientific resources, with hundreds of subject areas arranged in a manner familiar to educators. Using Spacelink Search, educators and students can easily find information among NASA's thousands of Internet resources. Special events, missions, and intriguing NASA Web sites are featured in Spacelink's "Hot Topics" and "Cool Picks" areas. Spacelink may be accessed at: <http://spacelink.nasa.gov>.

NASA Spacelink is the official home to electronic versions of NASA's Educational Products. A complete listing of NASA Educational Products can be found at the following address: <http://spacelink.nasa.gov/products>.



**NASA Television (NTV)** features Space Station and shuttle mission coverage, live special events, interactive educational live shows, electronic field trips, aviation and space news, and historical NASA footage. Programming has a 3-hour block—Video (News) File, NASA Gallery, and Education File—beginning at noon Eastern and repeated four more times throughout the day. Live feeds preempt regularly scheduled programming.

Check the Internet for programs listings at <http://www.nasa.gov/ntv>

For more information on NTV, contact

NASA TV

NASA Headquarters—Code P-2

Washington, DC 20546-0001

Phone: 202-358-3572

#### NTV Weekday Programming Schedules (Eastern Time)

<i>Video File</i>	<i>NASA Gallery</i>	<i>Education File</i>
12-1 p.m.	1-2 p.m.	2-3 p.m.
3-4 p.m.	4-5 p.m.	5-6 p.m.
6-7 p.m.	7-8 p.m.	8-9 p.m.
9-10 p.m.	10-11 p.m.	11-12 p.m.
12-1 a.m.	1-2 a.m.	2-3 a.m.

#### **How to Access Information on NASA's Education Program, Materials, and Services**

**(EP-2002-07-345-HQ)** This brochure serves as a guide to accessing a variety of NASA materials and services for educators. Copies are available through the ERC network, or electronically via NASA Spacelink.





**Amusement Park Physics With a NASA Twist**  
**A Middle School Guide for Amusement Park Physics Day**  
**EDUCATOR REPLY CARD**

To achieve America's goals in Educational Excellence, it is NASA's mission to develop supplementary instructional materials and curricula in science, mathematics, geography, and technology. NASA seeks to involve the educational community in the development and improvement of these materials. Your evaluation and suggestions are vital to continually improving NASA educational materials.

**Please take a moment to respond to the statements and questions below. You can submit your response through the Internet or by mail. Send your reply to the following Internet address:**

*[http://ehb2.gsfc.nasa.gov/educats/educator\\_guide](http://ehb2.gsfc.nasa.gov/educats/educator_guide)*

**You will then be asked to select the appropriate educator guide and enter your data at the appropriate prompt.**

Otherwise, please return the reply card by mail.

1. With what grades did you use the guide?

Number of teachers/faculty:

\_\_\_ K-4    \_\_\_ 5-8    \_\_\_ 9-12    \_\_\_ Community College

\_\_\_ College/University    \_\_\_ Undergraduate    \_\_\_ Graduate

Number of students:

\_\_\_ K-4    \_\_\_ 5-8    \_\_\_ 9-12    \_\_\_ Community College

\_\_\_ College/University    \_\_\_ Undergraduate    \_\_\_ Graduate

Number of others:

\_\_\_ Administrators/Staff    \_\_\_ Parents    \_\_\_ Professional Groups

\_\_\_ General Public    \_\_\_ Civic Groups    \_\_\_ Other

2. a. What is your home 5- or 9-digit zip code?    \_\_\_\_\_

b. What is your school's 5- or 9-digit zip code?    \_\_\_\_\_

3. This is a valuable guide.

Strongly Agree     Agree     Neutral     Disagree     Strongly Disagree

4. I expect to apply what I learned from this guide.

Strongly Agree     Agree     Neutral     Disagree     Strongly Disagree

Fold along line and tape closed.

5. What kind of recommendation would you make to someone who asks about this guide?  
 Excellent     Good     Average     Poor     Very Poor

6. How did you use this guide?

- Background Information     Critical Thinking Tasks     Demonstrate NASA Materials
- Demonstration     Group Discussions     Hands-On Activities
- Integration Into Existing Curricula     Interdisciplinary Activity     Lecture
- Science and Mathematics     Team Activities     Standards Integration
- Other: Please specify: \_\_\_\_\_

7. Where did you learn about this guide?

- NASA Educator Resource Center (ERC)
- NASA Central Operation of Resources for Educators (CORE)
- Institution/School System
- Fellow Educator
- Workshop/Conference
- Other: Please specify: \_\_\_\_\_

8. What features of this guide did you find particularly helpful?

\_\_\_\_\_

\_\_\_\_\_

\_\_\_\_\_

9. How can we make this guide more effective for you?

\_\_\_\_\_

\_\_\_\_\_

\_\_\_\_\_

10. Additional comments:

\_\_\_\_\_

\_\_\_\_\_

\_\_\_\_\_

Today's Date: \_\_\_\_\_

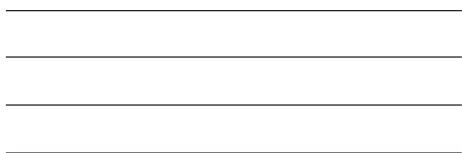

Please Place  
Stamp Here  
Post Office  
Will Not Deliver  
Without Proper  
Postage

**NATIONAL AERONAUTICS AND SPACE ADMINISTRATION  
EDUCATION DIVISION  
MAIL CODE FE  
WASHINGTON DC 20546-0001**

---

Fold along line and tape closed.